

## Contents

1.	Introduction.....	2
2.	Installation .....	2
3.	Warning – spectrum analyzer input rating.....	2
4.	Projects .....	3
5.	Workspace .....	4
6.	Features.....	4
7.	Implemented Standards .....	5
8.	Applications.....	5
9.	Connecting to the spectrum analyzer.....	9
10.	Prepare measurements .....	10
11.	Measurement.....	10
12.	SRC folder - General .....	11
13.	SRC folder – Limit files .....	12
14.	SRC folder - Segments .....	14
15.	SRC folder – compensation files .....	15
16.	SRC folder – project files .....	16
17.	Peak scan .....	16
18.	Final scan / peak re-measurement.....	18
19.	View / hide graphs .....	19
20.	Zoom graphs .....	20
21.	Amplitude units .....	20
22.	Markers .....	21
23.	Labels.....	22
24.	Options.....	23
25.	Fader .....	23
26.	Math.....	25
27.	Saving graphs and measurement results .....	26
28.	Control of additional equipment with EMCview .....	27
29.	Using RF current probe measurements to extrapolate to radiated E-field strength.....	29
30.	EN 61000-4-20 correlation .....	29
31.	Real time measurements .....	31
32.	Conducted immunity testing.....	33
32.1	AM versus CW.....	33
32.2	EN 61000-4-6, CDN.....	33
32.3	EN 61000-4-6, BCI .....	35
32.4	ISO 11452-4, BCI, Substitution Method.....	36
32.5	ISO 11452-4, BCI, Closed Loop Method.....	39
33.	Create Reports .....	40
34.	Tracking generator control mode for immunity testing.....	40
35.	RF coverage measurement mode.....	41
35.1	Configuration.....	41
35.2	Status and measurement results.....	42
35.3	Log file .....	42
35.4	KML file.....	43
36.	Further information.....	43
37.	History .....	43

## 1. Introduction

The EMCview software carries out automated conducted or radiated noise measurements. It currently supports all Rigol DSA and RSA spectrum analyzers, all Siglent SSA, SSA-plus, SVA models, Rohde & Schwarz FPC and FPH series analyzers, OWON XSA and HSA series, BK Precision models 2682/2683, ComPower SPA900 series, Teledyne LeCroy T3SA series, Multicomp MP700 series, TheEMCshop ESA series and the UNI-T UTS series. All relevant CISPR (= EN550xx) conducted and radiated noise measurement settings and more are pre-configured in the current version.

EMCview also supports RF-coverage measurements and tracking generator control for immunity testing. This manual reflects the state of EMCview V9.17. **Various screenshots may be based on older SW versions and slightly differ from the latest versions. As EMCview is a very dynamic project, have a look at our website from time to time for new releases with new features. As the manual is only updated for each major release, refer to the readme files and the EMCview FAQ document for more detailed information on features.**

## 2. Installation

Download and install the VISA driver package from the National Instruments website.

Download and install EMCview from the Tekbox website. Copy the license file into the same directory as EMCview.exe. Click EMCview.exe within your program directory or the desktop icon to run the program.

**Important:**

Rigol DSA815 FW  $\geq$  V00.01.16; Siglent SSA FW  $\geq$  1.2.9.3a; Siglent SVA FW  $\geq$  V2.2.1.2.1 or higher  
R&S FPC1500:  $\geq$  FW 1.5 PC-requirements: Windows 7, 8, 10; min 4MB RAM

**It is highly recommended to check the firmware download section of the spectrum analyzer manufacturer and install the latest firmware version.**

R&S FPC and FPH spectrum analyzers: In addition, install "R&S Instrumentview". Connect over USB cable via menu **Device, SA TCP** with "SA TCP" = 172.16.10.10. Connection over LAN is not recommended, as it works very slowly.

See chapter 6 on how to connect to the spectrum analyzer.

In case of any display issues, refer to chapter 12 of the EMCview FAQ document.

Check the Tekbox website for EMCview updates from time to time.

## 3. Warning – spectrum analyzer input rating

**Always consider the maximum input ratings of any spectrum analyzer. Be aware that powerful surges and harmonics of a DUT may have the potential to damage the spectrum analyzer input stage.**

Be aware, that EMCview project files are set up to utilize the maximum sensitivity of the spectrum analyzer. The requirements of certain standards are tough, especially those of CISPR 25 class 5 and manufacturer specific automotive conducted noise standards. Consequently, the internal attenuator is set to OFF and the internal preamplifier is set to ON in order to avoid crossing the limit lines with the noise level of the analyzer. Furthermore, all conductive noise measurement projects use the LISN correction file for disabled attenuator/limiter.

**Take following precautions to protect the spectrum analyzer input before testing an unknown DUT:**

**Check the attenuator and preamplifier settings of the segment file upfront to any measurement**

Be especially careful when testing conducted emissions of inductive loads such as motors or switched inductive loads.

Whenever measuring an unknown source or DUT, protect the spectrum analyzer input with the internal limiter an external attenuator of 20dB or 30dB and check the spectrum for any high amplitude signals.

Protect the spectrum analyzer input from harmful ESD events.

In case of conducted noise measurements with the 50 $\mu$ H LISN (TBLC08) follow the procedure in the LISN manual. With the LISN power switch OFF, the line selection switch OFF and the LISN attenuator/limiter on, first power the isolation transformer and thereafter turn ON the LISN power switch. Next, connect the powered spectrum analyzer via BNC cable to the LISN. The internal spectrum analyzer attenuator shall be ON and the internal preamplifier shall be OFF. It is a good practice to keep the spectrum analyzer RF input

disconnected or at least the line switch in OFF position when powering ON/OFF the DUT in order to protect the analyzer from potentially harmful switching transients.

In case of the 5 $\mu$ H LISN (TBOH01) use an external 20dB attenuator or consider using an external limiter such as the TBFL1 for a first check.

Before running a test with EMCview, monitor especially the frequency range 9 kHz to 2 MHz for potential high amplitude harmonics and check for spectrum analyzer messages "IF overload". Operate the spectrum analyzer with Max Hold for this purpose. In case of strong signals, increase the attenuator and reference Level of the analyzer or even add an external attenuator at the input.

**Modify the segment file with respect to attenuator and preamplifier settings accordingly. When doing a fast scan, consider the attenuator and preamplifier settings in the control box.**

Hint: attenuator and preamplifier settings in the segment files can easily be modified using a text editor with "find and replace all" capability.

## 4. Projects

In EMCview, any EMC standard is represented by one or more projects. A project summarizes all configurations necessary to carry out measurements. It consists of limit files, segment files, a cable file, a LISN file, an antenna file, an amplifier file and various settings such as graph boundaries, trace colors, and settings for peak measurements.

**Limit files:** configuration containing the frequency dependent limit values given in the corresponding standard.

**Segment files:** spectrum analyzer settings such as start and stop frequency, sweep time, resolution bandwidth, detector, attenuator and preamplifier settings. Refer to the CISPR16 standard or to the Tekbox document *Pre Compliance Conducted Emission Measurements V1\_1.pdf* for more detailed information. Radiated noise measurements often cover a wide frequency span and require different antennas for different frequency ranges. Consequently, it makes sense to split segment files. Segment files for radiated noise typically cover 150kHz -30MHz, 30MHz-300MHz, 300MHz-1GHz, 1GHz – 1,5GHz (DSA815 frequency range), etc.

**LISN files:** insertion loss/calibration data of the LISN over frequency, entered in dB with negative sign. Use LISN files also to implement conversion from dB $\mu$ V to dB $\mu$ A for conducted noise measurements with RF current probes. The default 50 $\mu$ H LISN file is using the correction data for the attenuator/limiter in OFF position. If you measure with attenuator/limiter engaged, select the corresponding LISN file.

**Antenna files:** antenna factor of the antennas used for radiated noise measurement; converts the dB $\mu$ V measured by the spectrum analyzer into dB $\mu$ V/m

**Cable files:** insertion loss of cables between DUT and spectrum analyzer

**Gain files:** amplifier gain or attenuator loss in the signal path, if any

These files can be created or edited either with a built in editor in the **Setup Menu** or with any text editor. The files are located in the **src** subdirectory. Press the **Tab** key after loading any configuration file.

Project files for conducted noise measurements have file names starting with CN\_\*.prj. Project files for radiated noise measurements with antennas start with RN\_\*.prj. Project files for radiated noise measurements with TEM cells start with TC\_\*.prj.

Refer to the applicable standards for more details and insight. Standards and corresponding limits may change over time. Tekbox does not take any liability for the validity of the limits and other settings in the preconfigured projects.

Consider that most segment files have the default attenuator settings at 0dB and in some cases such as CISPR 25 the preamplifier of the spectrum analyzer is set to ON in order to achieve maximum sensitivity. When testing any device with switched mode power supplies, consider to change the attenuator setting to 10dB for the first run.

Also in case of an "IF Overload" message of the analyzer, stop the measurement and disconnect the analyzer and increase the attenuator setting before proceeding with the measurement.

## 5. Workspace

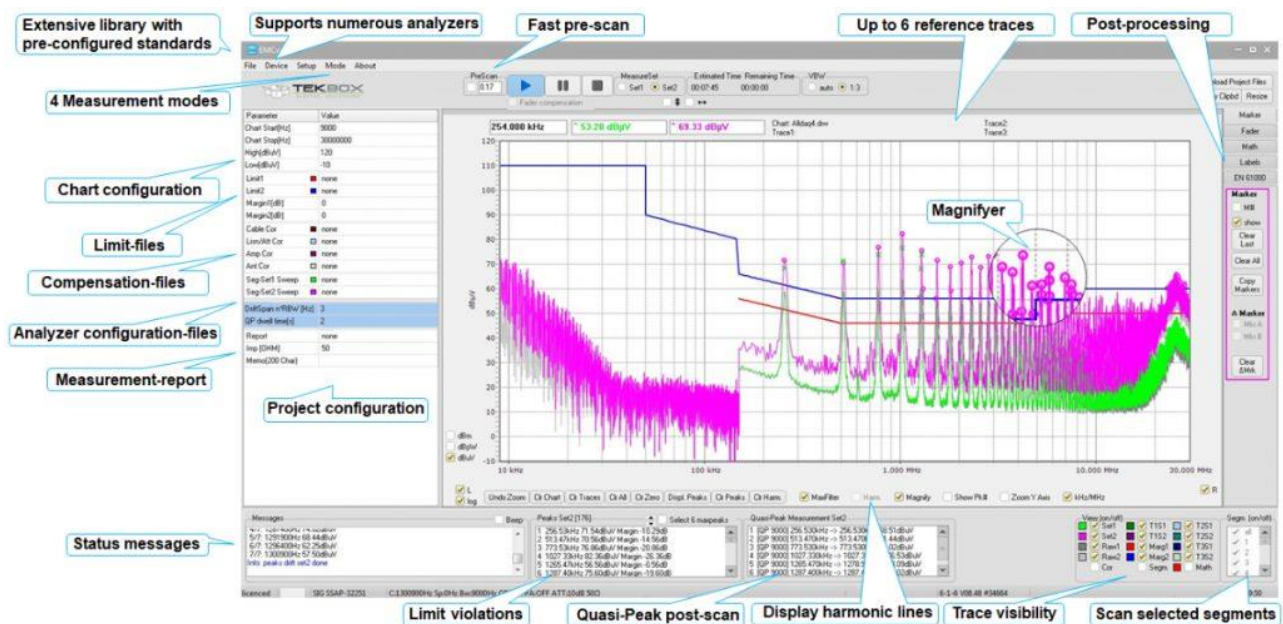

## 6. Features

- numerous pre-configured project files for all relevant EMC standards
- Graph supports two complete measurement runs, same as in test house; simultaneous measurement with two detectors available for a few analyzers
- fast Quasi-Peak scan of critical peaks, immune to frequency drift of the selected peaks
- Fast pre-scan
- configurable limit lines and segment files
- configurable correction files for cables, LISN, amplifiers, antennas, current probes, etc.
- configurable margins for the identification and selection of critical peaks
- supports import and overlaying of reference measurements for comparison purpose
- linear or logarithmic frequency axis
- Harmonic markers
- automatic creation of test reports
- many import/export-functions
- graphs can be saved as charts containing meta-data, graphs can be loaded together with the corresponding measurement configuration
- RF coverage measurements
- tracking generator control for immunity testing using TEM cells
- many post-processing features
- useful calculators
- Immunity testing using CDNs or BCI probes; requires EMCview PRO license
- Rapid measurement, supporting real time bandwidth capability of Siglent SSA3000X-R series and Rigol RSA series; requires EMCview PRO license

## 7. Implemented Standards

Implemented Standards	Description
<b>CISPR 16 / EN 55016</b>	Base standard used by EMCview for control and settings of the spectrum analyzers during measurement
<b>CISPR 11 / EN 55011</b>	Industrial, scientific and medical equipment - Radio-frequency disturbance characteristics - Limits and methods of measurement
<b>CISPR 12 / EN 55012</b>	Vehicles, boats and internal combustion engines - Radio disturbance characteristics - Limits and methods of measurement for the protection of off-board receivers
<b>CISPR 13 / EN 55013</b>	Sound and television broadcast receivers and associated equipment -Radio disturbance characteristics - Limits and methods of measurement; replaced by CISPR 32
<b>CISPR 14 / EN 55014</b>	Electromagnetic compatibility - Requirements for household appliances, electric tools and similar apparatus
<b>CISPR 15 / EN 55015</b>	Limits and methods of measurement of radio disturbance characteristics of electrical lighting and similar equipment
<b>CISPR 22 / EN 55022</b>	Information technology equipment – Radio disturbance characteristics – Limits and methods of measurement; replaced by CISPR 32
<b>CISPR 25 / EN 55025</b>	Vehicles, boats and internal combustion engines - Radio disturbance characteristics - Limits and methods of measurement for the protection of on-board receivers
<b>CISPR 32 / EN 55032</b>	Electromagnetic compatibility of multimedia equipment - Emission requirements
<b>CISPR 36 / EN 55036</b>	Electric and hybrid electric road vehicles - Radio disturbance characteristics - Limits and methods of measurement for the protection of off-board receivers below 30 MHz
<b>IEC / EN 61000-6-3</b>	generic EMC emission standard applicable only if no relevant dedicated product EMC standard has been published; residential environments
<b>IEC / EN 61000-6-4</b>	generic EMC emission standard applicable only if no relevant dedicated product EMC standard has been published; industrial environments
<b>IEC / EN 300330</b>	Short Range Devices; Radio equipment in the frequency range 9 kHz - 25 MHz and inductive loop systems in the frequency range 9 kHz - 30 MHz
<b>IEC / EN 60945</b>	Maritime navigation and radiocommunication equipment and systems
<b>EN 15194</b>	Electrically power assisted cycles
<b>MIL-STD-461G</b>	United States Military standard for electromagnetic compatibility
<b>DO-160</b>	Avionics
<b>FCC15 Subpart B</b>	FCC emission limits for two major classes of unintentional radiators
<b>IEC / EN 61000-4-6</b>	Immunity to conducted disturbances, induced by radio-frequency fields; used for immunity feature in EMCview PRO
<b>ISO 11452-4</b>	Road vehicles - Component test methods for electrical disturbances from narrowband radiated electromagnetic energy; used for immunity feature in EMCview PRO
<b>IEC / EN 61000-4-20</b>	Emission and immunity testing in transverse electromagnetic (TEM) waveguides; used for Near-field to far-field correlation feature in EMCview

## 8. Applications

### Conducted emission testing using LISN

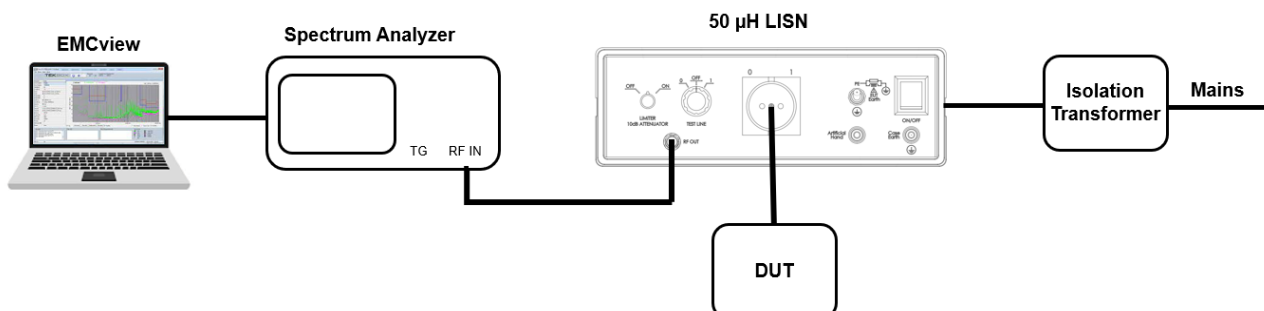

## Conducted emission testing using LISN

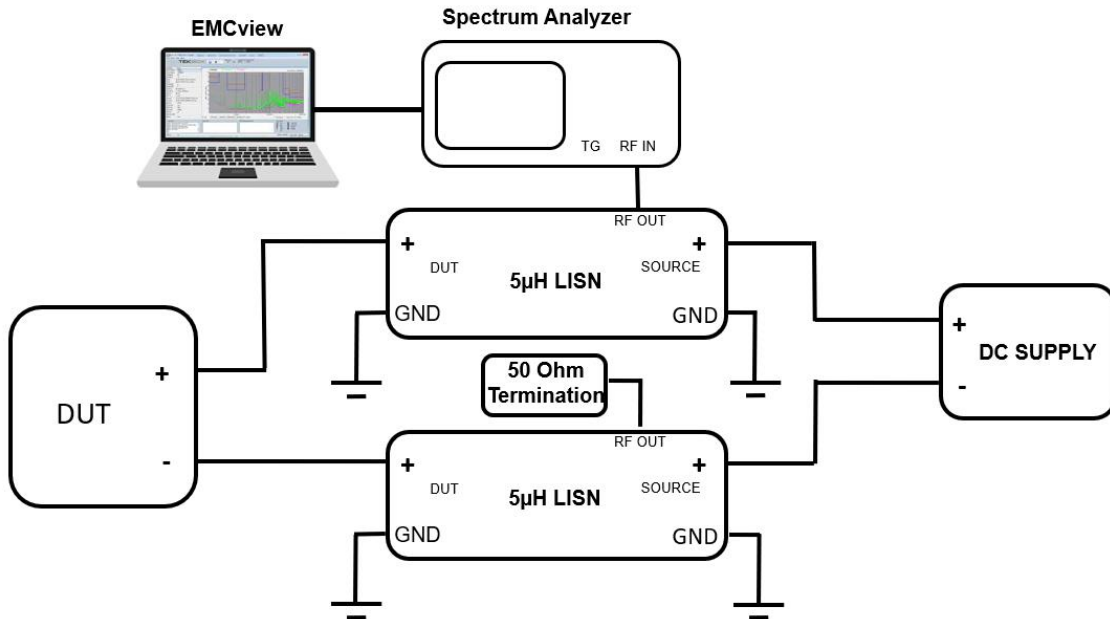

## Conducted emission testing using a RF current monitoring Probe

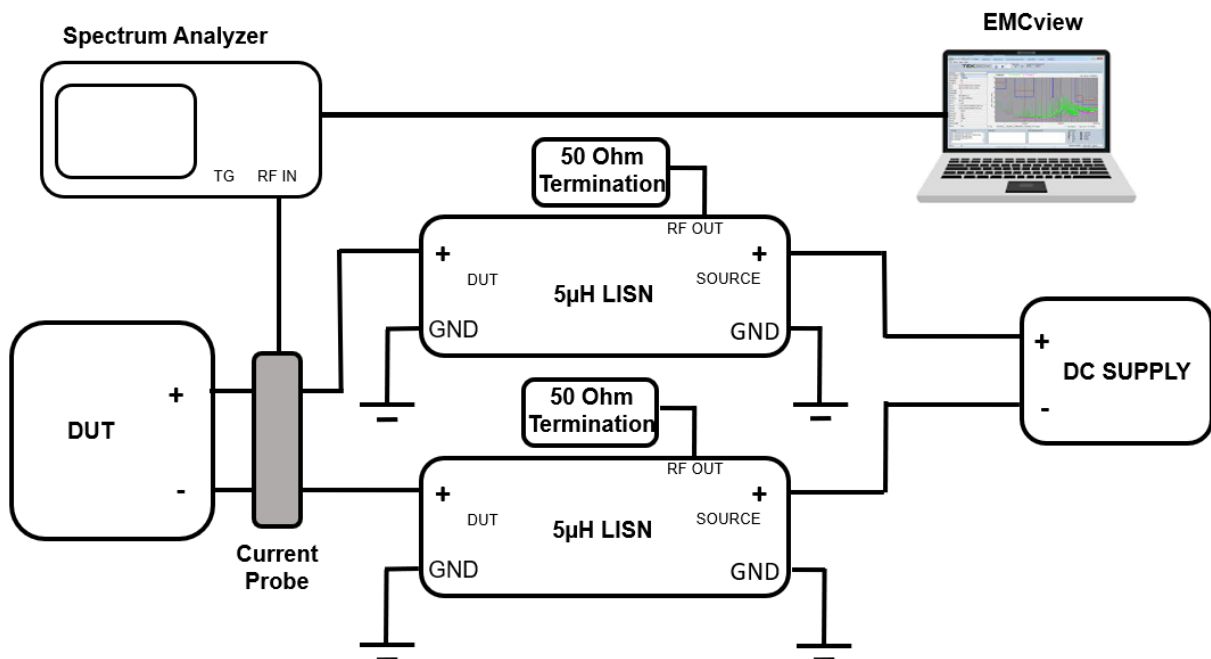

## Radiated emission testing using a measurement antenna

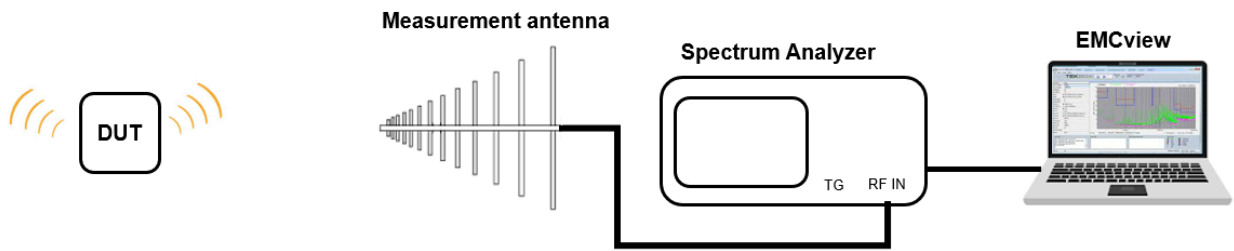

## Radiated emission testing using a TEM-cell

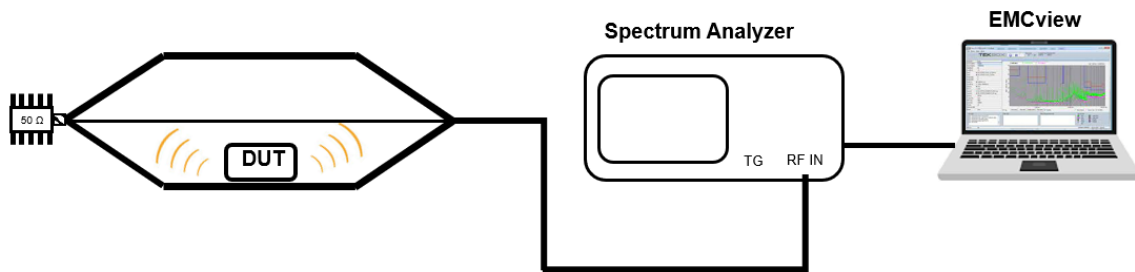

## Immunity testing using a TEM-cell

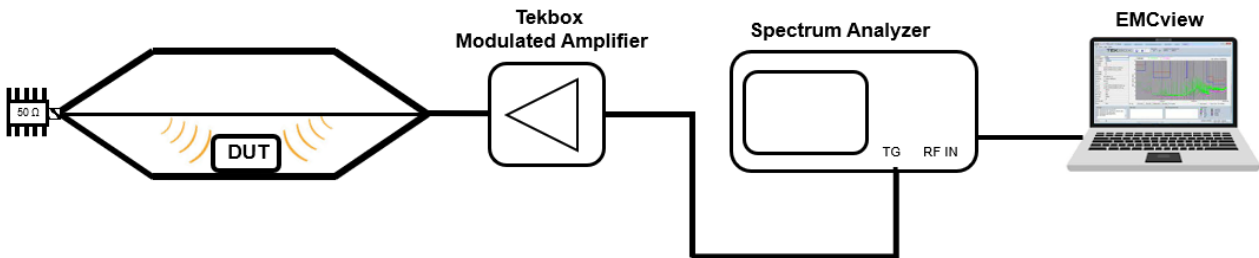

## Immunity testing using near field probes

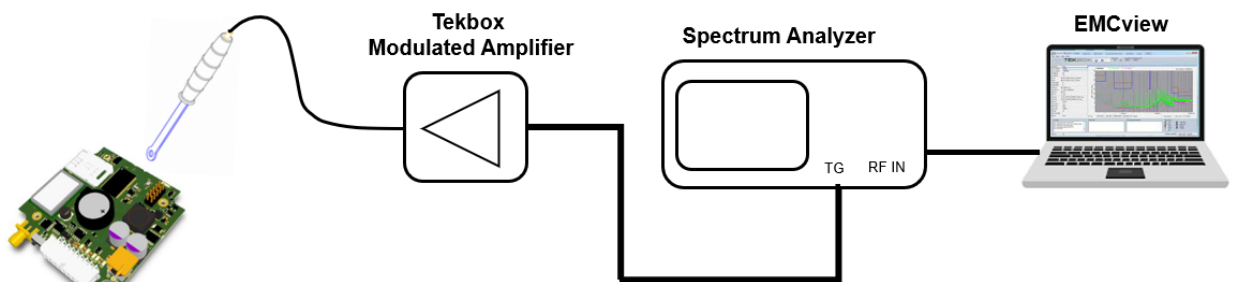

**EN 61000-4-6 calibration set up using EMCview PRO**

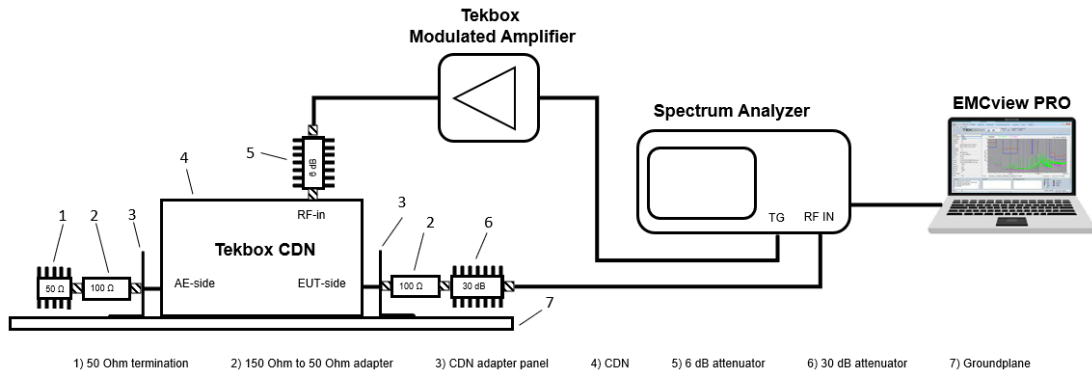

**EN 61000-4-6 immunity test set up using EMCview PRO**

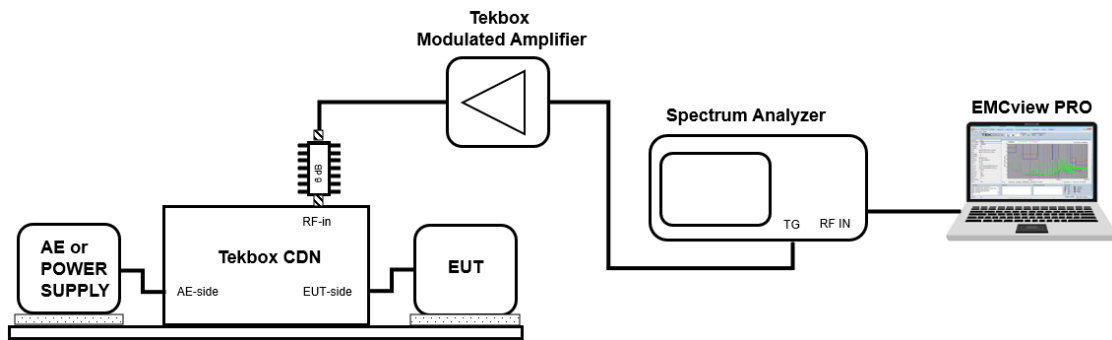

**EN 61000-4-6 300 Ohm loop BCI calibration set up using EMCview PRO**

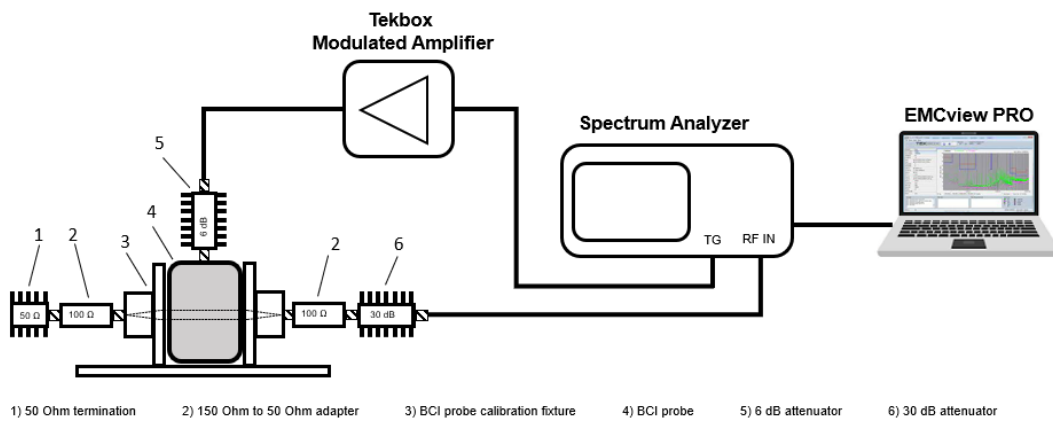

**EN 61000-4-6 immunity test set up using a BCI probe using EMCview PRO**

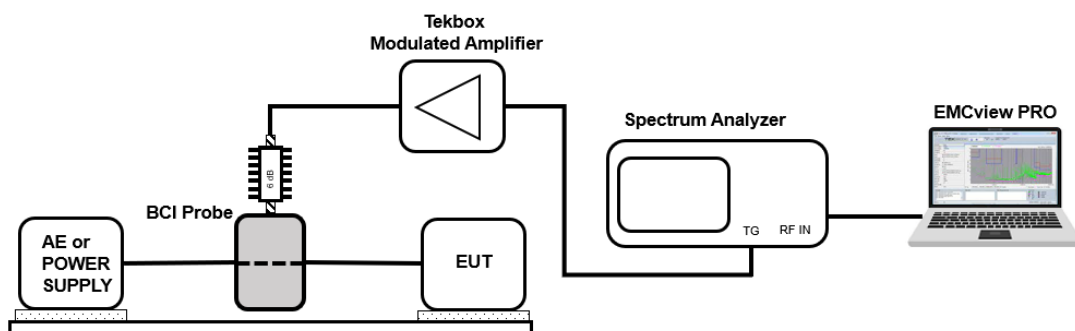



ISO 11452-4 Conducted immunity measurement using EMCview PRO

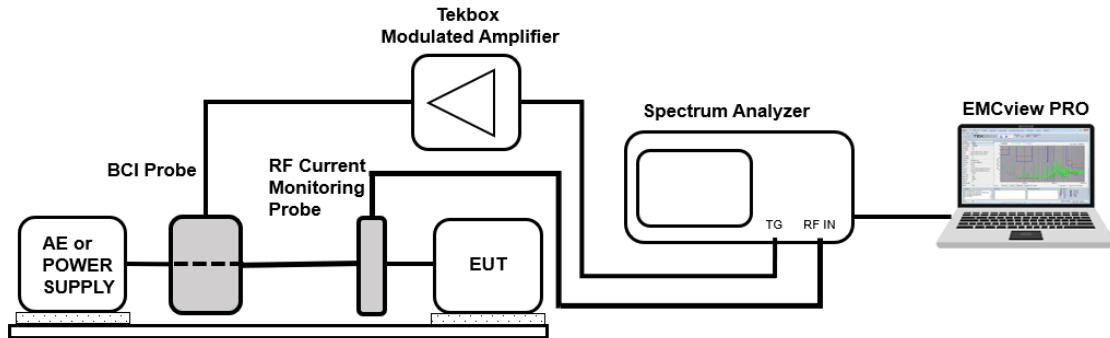

9. Connecting to the spectrum analyzer

**Via USB:** Launch EMCview and connect the spectrum analyzer to the PC via USB. In the menu line, click **DEVICE**, then **SA USB** and **SEARCH**. You should then see the Rigol analyzer listed in the search window. Click at the line with the Rigol Analyzer and then click the **CONNECT VISA** button. You can validate the connection by clicking the **GET INFO** button. Furthermore, you should see a “licensed” status message in the very left lower corner of EMCview. Close the window with the **x** button. Do not close it with the **Disconnect Visa** button, as it would disconnect the spectrum analyzer.

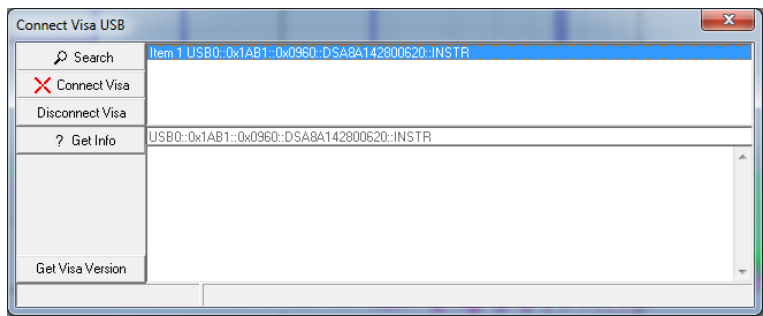

Note: When connecting R&S FPC and FPH series via USB, click **DEVICE**, then **SA TCP**. Enter 172.16.10.10 into the IP address field.

**Via Ethernet:** Launch EMCview and connect the spectrum analyzer to the PC via an Ethernet cable. On the analyzer LAN settings, change to manual IP and enter an IP address, e.g. 192.168.10.205. In the menu line, click **DEVICE**, then **SA TCP**. Enter the IP address of the spectrum analyzer into the box at the upper right corner. Click the **CONNECT VISA** button. You can validate the connection by clicking the **GET INFO** button. Furthermore, you should see a “licensed” status message in the very left lower corner of EMCview. Close the window with the **x** button. Do not close it with the **Disconnect Visa** button, as it would disconnect the spectrum analyzer.

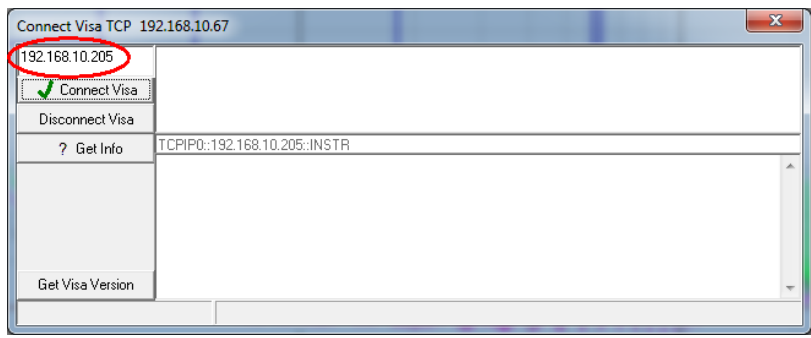

## 10. Prepare measurements

Click **File, Load Project** and select an appropriate standard for your EUT. Each standard directory is divided into two subdirectories: CN (conducted emission projects) and RN (radiated emission projects).

The folder **EMCview\Doku** contains thorough documentation for all standards that have been implemented. The predefined limit lines and segment files for the selected standard will pop up in the configuration section at the left side of the screen. The limit lines will appear in the graph chart.

To create additional standards, you can generate new limit lines, segment files, and correction files in the **Setup** menu. Alternatively, and most likely faster, you can use a text editor to copy, rename, and modify one of the existing files.

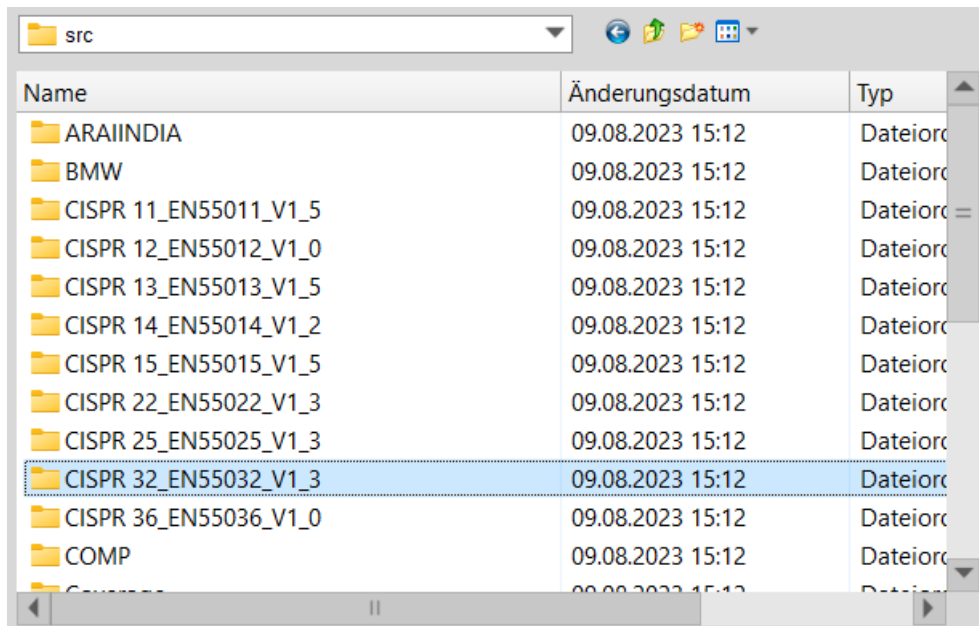

If you edit any configuration file during runtime of EMCview, press the **Reload Project files** button in the right upper corner.

## 11. Measurement

After correct set up and configuration, just press the **Play** button at the top of the window. The analyzer will start carrying out the measurement defined in *Segment-Set 1*. The associated limit line is *Limit1*. After the measurement is completed, click the *Set2* button at the top of the window. Press the **Play** button. The analyzer will start carrying out the measurement defined in *Segment-Set 2*. The associated limit line is *Limit2*.

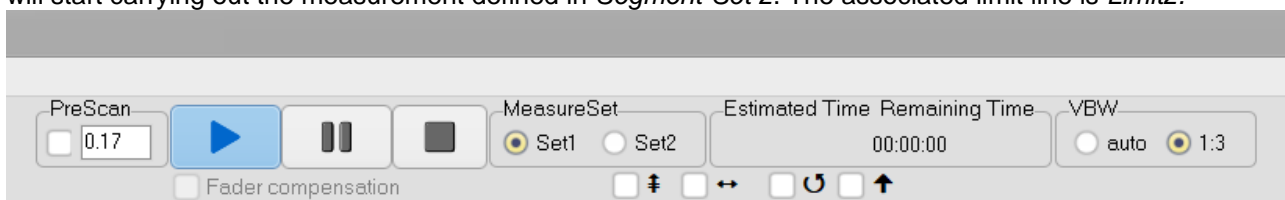

Most project files define Peak or Average measurements as Set1 and Quasi-Peak measurements as Set2. By default, all segments are measured and displayed consecutively.

If you want to perform a quick pre-measurement, turn on PreScan. Changing the PreScan parameter will change the sweep time. Pre-scans do not produce CISPR-compliant data and are just designed to provide a rapid overview of the spectrum..



**Repetitive Measurement** and **Max Hold** need to be enabled in the **Setup, Options** menu upfront.

## 12. SRC folder - General

The SRC – folder is a sub directory of the installation directory of EMCview. The SRC folder contains:

- Project files, which define graph boundaries – start frequency, stop frequency, minimum amplitude, maximum amplitude reference limit line files – conducted emission limits, radiated emission limits as per relevant standard reference segment files – spectrum analyzer parameters such as start frequency, stop frequency, RBW, detector, sweep time, internal attenuation, pre-amplifier setting define settings for peak re-measurement
- Limit files, which then are loaded and displayed on the graph
- Segment files, which control the spectrum analyzer settings and measurement
- Compensation files, which characterize hardware such as LISN, current probes, antennas, amplifiers, attenuators, cables and any other devices which influence the frequency response of the measurement set up.

Up to EMCview V7.0, the SRC folder did not contain any sub directories. With V7.0, each standard is contained in an individual sub directory, which then contains further sub directories for conducted noise, radiated noise and TEM cell measurements, where foreseen by the standard. There is also a separate sub directory for compensation files. All files in the SRC folder are plain text files, which can be created or edited with any text editor. Alternatively, the files can be created within EMCview menu **SETUP**, however using a text editor is most probably a more efficient method.

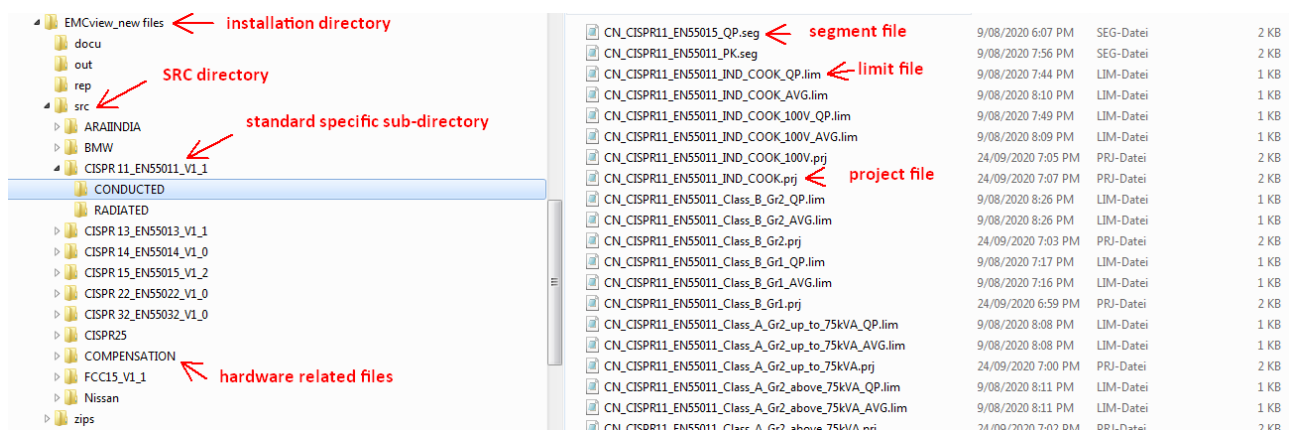

It is important to understand, that the SRC folder remains untouched, when updating EMCview. This prevents overwriting or deleting any files, which were created or modified by the user. Consequently, any new projects, which may have been added to the updated software, will not be added during the installation process. In order to have the SRC directory updated during a SW update, save your customized files to another directory and then delete the SRC directory. Thereafter you can merge your customized files with the updated SRC directory. Alternatively, create another installation directory for EMCview, such as C:\EMCview\_NEW, etc.

## 13. SRC folder – Limit files

Each limit file can contain a main limit line as well as up to 15 auxiliary limit lines. EMCview can also provide a margin line for the main limit line. The main limit line will serve as a reference for margin lines and will be utilized to calculate peaks that exceed the main limit line or the margin line.

Auxiliary limit lines are essentially graphic content that cannot be used for processing.

Auxiliary limit lines can be segmented or interrupted; however main limit lines must be cohesive.

Example: CISPR22 Class A and Class B as main limit lines and FCC 15 Class A and FCC 15 Class B as auxiliary limit lines

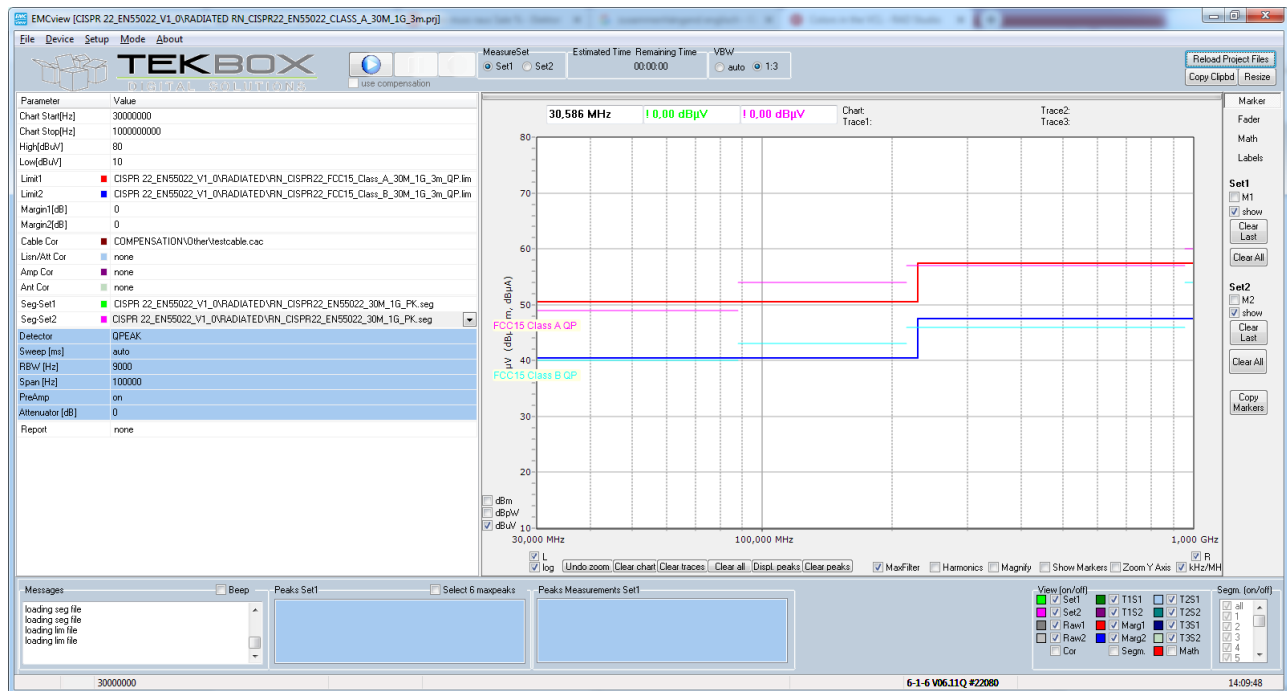

### Limit File syntax:

[Application]

Software=TekBox RP-W32-D7

Version=Demo

Date=18.01.2017 09:42:29

[General]

Name=RN\_CISPR22\_FCC15\_Class\_A\_30M\_1G\_3m\_QP.lim \* file name

Freq\_Interplot\_Mode=lin

Level\_Interplot\_Mode=log

[Data]

Freq1=30.000.000

Lev1=50.5

Freq2=230.000.000

Lev2=50.5

Freq3=230.000.010

Lev3=57.5

Freq4=1.000.000.000

Lev4=57.5

[Data\_Limit1]

Caption=FCC15 Class A QP

Color=\$FF00FF

Style=psSolid

Freq1=30.000.000

Lev1=49.6

Freq2=88.000.000

Author: Mayerhofer

\* start header

\* Main limit line (CISPR 22 Class A)

\* first frequency point [Hz]

\* amplitude level of the first frequency point [dBμV]

\* second frequency point

\* amplitude level of the second frequency point [dBμV]

\* third frequency point (using a point with 10 Hz offset creates a vertical step and keeps the line coherent)

\* amplitude level of the last point of the main limit line

\* start first auxiliary limit line (FCC 15 Class A)

\* text label for 1<sup>st</sup> auxiliary limit line

\* line color "Fuchsia" (alternatively enter clFuchsia instead of the Hex value)

\* line style "solid"

\* first frequency point of auxiliary limit line [Hz]

\* amplitude of the first frequency point of the first limit line [dBμV]

\* second frequency point of auxiliary limit line [Hz]

Lev2=49.6  
 Break2=1  
 Freq3=88.000.000  
 Lev3=54  
 Freq4=216.000.000  
 Lev4=54  
 Break4=1  
 Freq5=216.000.000  
 Lev5=56.9  
 Freq6=960.000.000  
 Lev6=56.9  
 Break6=1  
 Freq7=960.000.000  
 Lev7=60  
 Freq8=1.000.000.000  
 Lev8=60  
 [Data\_Limit2]  
 Caption=enter label here  
 Color=\$FFFF00  
 Style=psDash  
 Freq1=.....  
 .....

- \* amplitude of the second frequency point of the first limit line [dBµV]
- \* suppress the limit line between second and third frequency point
- \* third frequency point of auxiliary limit line [Hz]

- \* end of 1<sup>st</sup> auxiliary limit line
- \* start 2<sup>nd</sup> auxiliary limit line
- \* text label for auxiliary limit line
- \* line color "Aqua" (alternatively enter clAqua instead of the Hex value)
- \* line style "dashed"

Colors:

Value	Meaning	Hex Value	Color
clBlack	Black	\$000000	Black
clMaroon	Maroon	\$000080	Maroon
clGreen	Green	\$008000	Green
clOlive	Olive Green	\$008080	Olive Green
clNavy	Navy Blue	\$800000	Navy Blue
clPurple	Purple	\$800080	Purple
clTeal	Teal	\$808000	Teal
clGray	Gray	\$808080	Gray
clSilver	Silver	\$C0C0C0	Silver
clRed	Red	\$0000FF	Red
clLime	Lime Green	\$00FF00	Lime Green
clYellow	Yellow	\$00FFFF	Yellow
clBlue	Blue	\$FF0000	Blue
clFuchsia	Fuchsia	\$FF00FF	Fuchsia
clAqua	Aqua	\$FFFF00	Aqua
clWhite	White	\$FFFFFF	White
clMoneyGreen	Mint Green	\$C0DCC0	Mint Green
clSkyBlue	Sky Blue	\$F0CAA6	Sky Blue
clCream	Cream	\$F0FBFF	Cream
clMedGray	Medium Gray	\$A4A0A0	Medium Gray
clNone	Represents no colors (black)	\$1FFFFFFF	Black

Line styles:

- psSolid
- psDash
- psDot
- psDashDot
- psDashDotDot

Limit lines are linked to a corresponding segment file. Limit 1 is coupled with Segment Set1 and Limit 2 is coupled with Segment Set2.

Labels of auxiliary limit lines can be moved, by dragging it with the mouse.

Interrupted main limit lines, such as specified for example in CISPR 25 are created by setting the frequency sections without limitations to a high value such as for example 150 dBµV and thereby shifting it outside the upper amplitude boundary of the graph window (though of course, the upper boundary could be as high or higher than 150dBµV]. Vertical steps are created by entering two frequency points very close to each other. Use a frequency difference of 10 Hz between the two adjacent points, for example. See [Freq2](#) and [Freq3](#) in the example file above.

The default color of main limit lines can be modified in the **SETUP** menu. The line style is always solid. Color and line style of auxiliary limit lines can be edited or modified inside the limit file, as shown in the example above.

## 14. SRC folder - Segments

It is very important to understand the concept of segments. A segment defines a frequency sweep of the spectrum analyzer. A segment is a piece of frequency spectrum, with a defined start frequency and a defined stop frequency of the sweep. Segments are defined in the segment files, which are located in the **src** folder of the EMCview directory. Segment files can be identified by the **.seg** extension. A segment file basically defines a measurement run. The entire frequency span of the measurement run is split into many adjacent frequency segments, means a series of frequency sweeps, which will be measured consecutively. EMCview then stitches together the results of the individual sweeps to a single graph.

You may ask, why the entire spectrum is not measured just with a single sweep. A sweep is not a continuous measurement, but a series of discrete frequency steps, at which measurements are taken. A typical spectrum analyzer for EMC pre-compliance measurements has a display with 601 pixels in X (frequency)-axis direction. Consequently a sweep is divided into 601 discrete frequency steps.

A consequence of this architectural detail can be seen, if you set your spectrum analyzer to full span and feed it with a constant frequency signal, e.g. 98 MHz. Assuming a full span of 3 GHz, measurement point # 19 is at 95 MHz and measurement point #20 is at 100 MHz. Full span resolution bandwidth typically is set to 1 MHz. Pressing max peak at the analyzer will detect the maximum amplitude at measurement point #20 and consequently report a peak at 100 MHz and not at 98 MHz. Worse, depending on the frequency offset of the applied signal with respect to the nearest measurement point, it will also report a lower amplitude, as the applied signal sits somewhere at the shoulder of the RBW filter.

To prevent incorrect measurements, CISPR 16 specifies that adjacent frequency points shall not be spaced more than half the resolution bandwidth of the analyzer. As an example, CISPR band B, the frequency range 150 kHz to 30 MHz, must be measured with a resolution bandwidth of 9 kHz. This results in a frequency spacing of 4.5 kHz between adjacent measurement points and a maximum sweep span of  $601 * 4.5 \text{ kHz} = 2.7 \text{ MHz}$ .

Consequently, a CISPR compliant measurement can only be carried out in slices. Doing it manually would be very inefficient and this is why automatic measurement tools such as EMCview are needed for any serious pre-compliance tests.

Segment files of EMCview do not only define the start and stop frequencies of sweeps, but also set additional spectrum analyzer parameters which will be associated to every single frequency segment:

Resolution Bandwidth - EMC standards specify the RBW depending on the frequency band

Sweep time – EMC standards specify the sweep time depending on RBW and detector type

Detector – EMC standards specify which detectors need to be engaged

Internal Attenuator – the internal attenuator setting effects the base noise level of the spectrum analyzer. At the same time, the user must be aware of potentially overdriving the analyzer input and potential intermodulation distortion which would falsify the measurement.

Internal Pre-amplifier – activating the internal pre-amplifier will lower the base noise of the analyzer. This may be necessary for standards which have very low limits. However, similar considerations as for the internal attenuator have to be applied.

As mentioned, segment files are located in the **src** folder of the EMCview directory. They are plain text files and can be edited or created with the built in editing feature in menu **Setup / Edit Segments**, or perhaps more simply and conveniently with any text editor. A segment will look as below:

FRQa__1=9.000	* segment number (#1) and start frequency (9 kHz) of the segment
FRQb__1=50.000	* segment number (#1) and stop frequency (50 kHz) of the segment
BW____1=200	* segment number (#1) and RBW (200 Hz) of the segment
Sweep_1=1000000	* segment number (#1) and sweep time (1000000 ms) of the segment
Att__1=0	* segment number (#1) and internal attenuation (0dB) of the segment
PreAmp1=off	* segment number (#1) and pre amplifier setting (off) of the segment
Detector1=QPEAK	* segment number (#1) and detector type (quasi peak) of the segment

If you want to focus on a certain frequency range when carrying out EMC related improvements of a DUT, you can shorten time by selectively measure the segments of interest:

Activate displaying the segments by clicking the corresponding box in **View (on/off) / Segment**. You will then get the frequency segments displayed at the bottom of the graph. Select the segments that you want to measure in the **Segments (on/off)** box. Upon starting a measurement, only the selected segments will be measured and other segments will be skipped.

By default, skipped segments will be replaced with a straight line. Alternatively, in menu **Setup / Options / Misc**, you can select keeping segments from the previous measurement, when skipping it in consecutive measurements.

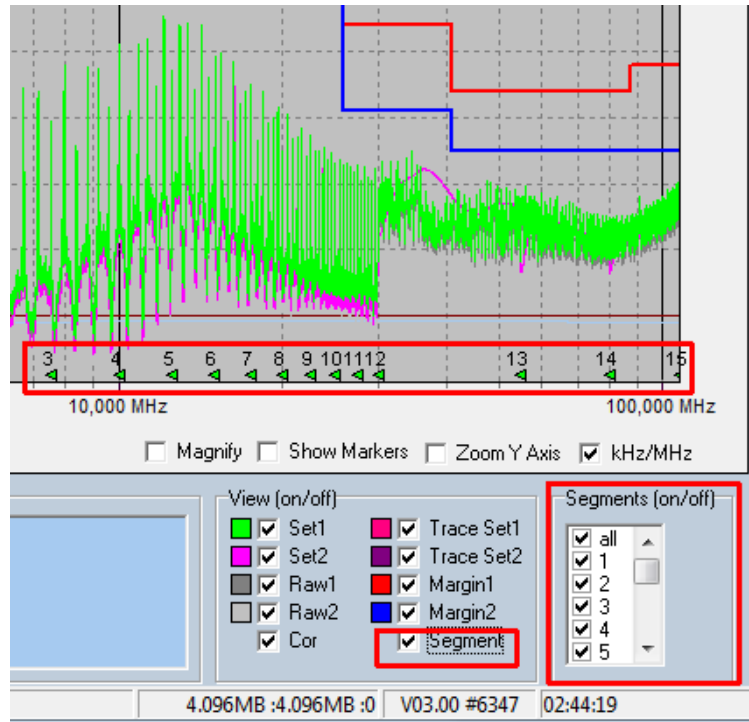

As Quasi-Peak measurements take much time, an alternative, time saving measurement method is recommended.

Use a scan with Peak detector and then compare the result against the Quasi-Peak limits. The result of the Peak detector is always higher or worst case same as the result of a measurement with Quasi Peak detector. This means, that when passing the Quasi Peak limits with a Peak detector measurement, the DUT is definitely compliant with Quasi-Peak limits. If the result of the Peak measurement exceeds Quasi Peak limits, there is still the chance that a measurement with Quasi Peak detector would be within the Quasi Peak limits. Consequently, a selective Quasi Peak measurement will be carried out, which only looks at the spurious frequencies where the Quasi Peak limit is exceeded.

The Peak Scan chapter further down describes how such a measurement is carried out.

Pressing the **Pause** button interrupts ongoing measurements. The current segment will however be completed, before the measurement pauses. To continue the measurement, press the **Play** button.

## 15. SRC folder – compensation files

Any measurement setup has a frequency response which needs to be compensated. The measurement data delivered by the spectrum analyzer is considered “raw-data”. In order to display Raw Data, activate the **RAW1**, **RAW2** check boxes in the **View (on/off)** menu at the right bottom of the EMCview window.

In order to convert the Raw Data into a valid response, compensation files have to be applied. This could be the LISN file or the trans-impedance file of a current probe in case of conducted noise measurements. In case of a radiated noise measurement, an antenna factor file would describe the antenna properties and provide the dB $\mu$ V to dB $\mu$ V/m conversion. The measurement set up may also contain cable losses, amplifiers or attenuators that need to be taken into calculation. The combined frequency response can be displayed by activating the **Cor** box in the **View (on/off)** menu at the right bottom of the EMCview window.

Open existing files from within the COMPENSATION sub directory of the SRC folder to see how to create it. A compensation file is composed of frequency points with the corresponding value (gain, attenuation, antenna factor, trans-impedance, etc.)

The frequency range of the compensation file should always cover at least the span of the segment file of the corresponding project.

Consider the calculation below, if you are not sure about which sign needs to be entered for the compensation values:

**Graph amplitude = Raw amplitude [dB $\mu$ V] – cable file [dB] – LISN file [dB] + ant file [dB] – amp file [dB]**

Raw amplitude: spectrum analyzer measurement values

For more information, such as how to deal with current monitoring probe trans-impedance, antenna factors, unit conversion and other operations that can be carried out using the correction files, have a look at our EMCview application notes.

Compensation files for Tekbox products can be downloaded on the corresponding product pages of the Tekbox website.

## 16. SRC folder – project files

Project files contain a summary of settings for a dedicated measurement set up. In contrary to limit files, segment files and compensation files, which are created with an editor, project files are usually created from within EMCview, by setting the graph boundaries, loading the desired limit files and segment files and then saving it as a project using menu **File / Save Proj.**

Nevertheless, a user familiar with EMCview, may also use a text editor to create project files.

EMCview contains a large number of pre-defined projects. The projects are loaded using menu **File / Load Proj.** Most conducted noise projects reference to Tekbox LISN or current probes. They can easily be changed, if you have measurement equipment from other manufacturers. Other projects may not yet contain any compensation files and need to be completed with suitable files for the equipment of your measurement set up.

Tekbox will regularly provide updates with additional projects. They are part of the installation package, but they can also be downloaded separately from our web site and manually copied into the SRC folder. Tekbox also provides compensation files for Tekbox products, which you can find on the corresponding product pages of [www.tekbox.com](http://www.tekbox.com).

## 17. Peak scan

Any measurement value of the Set1 run that violates the limit line is indicated with a small bubble on top of the peak. Activating the **MaxFilter** box at the bottom of the graph will only mark the highest peaks, if several consecutive measurement values violate the limit lines.

You can define **Margins** with respect to the limit lines of each measurement set. The SW would then indicate peaks, which cross the margin lines.

Enter the margin with positive sign to create a dashed line offset below the limit line. Margins with negative sign can be created as well.



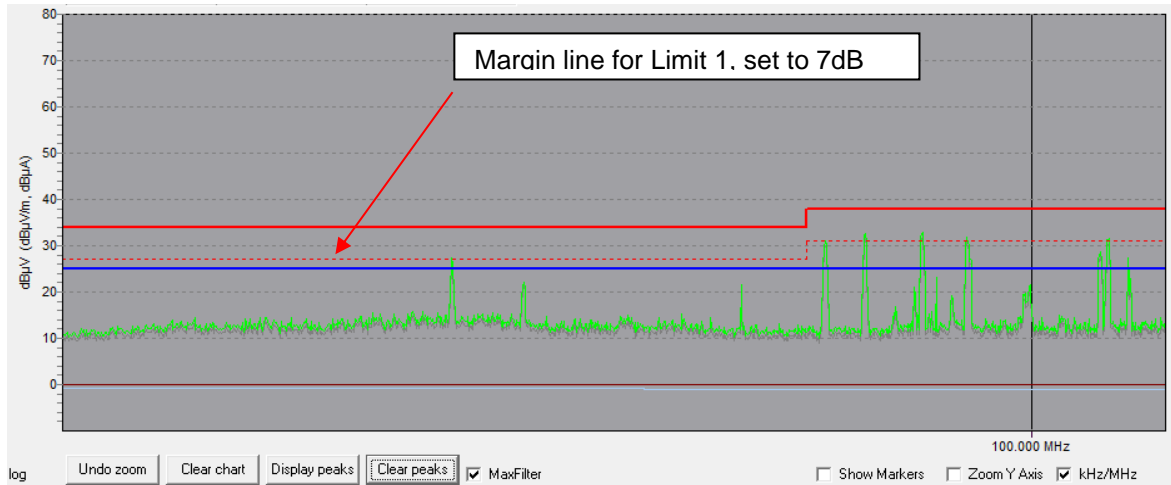

By default, the margins are set to 0, so any peak crossing the limit line would be indicated. Setting margin1 to e.g. 7dB would select all peaks coming within 7 dB close to the limit line of the graph measured with Settings1. Peaks crossing the margin line or limit line can be listed in the in the **Peaks window** by pressing the **Display peaks** button. See chapter 19 on how to manually select peaks and transfer it into the peaks list.

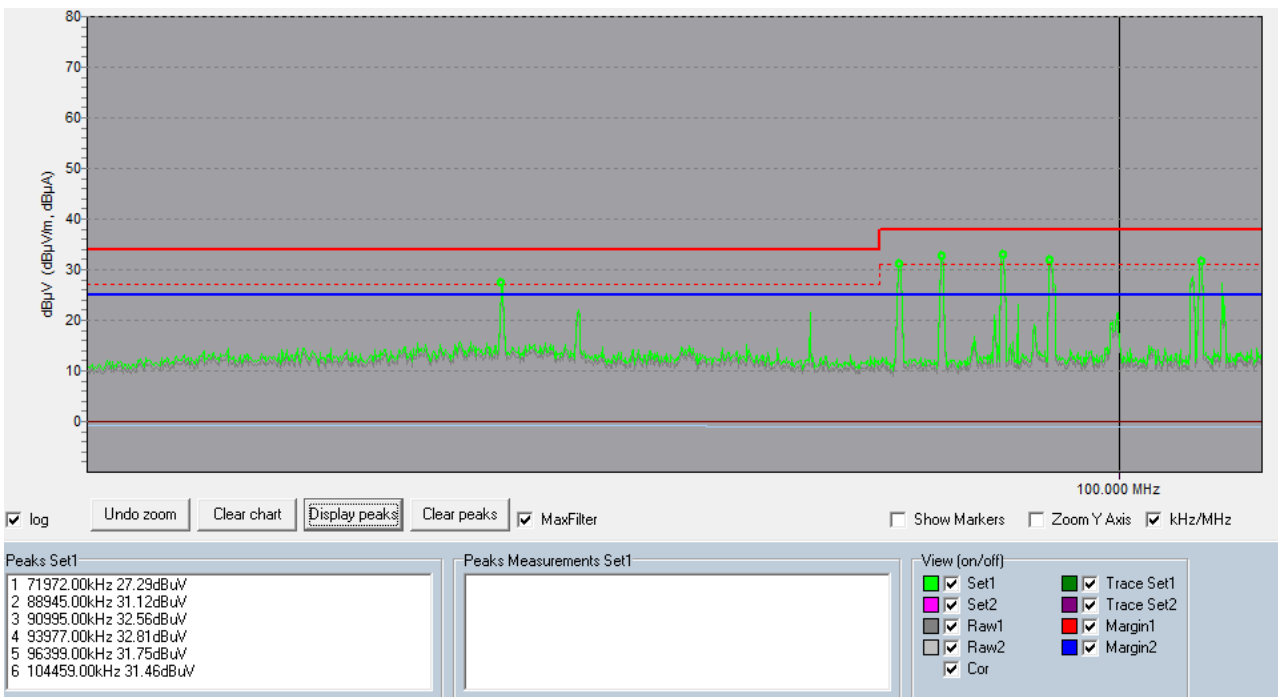

In order to display peaks for the second graph, change **MeasureSet** to set 2

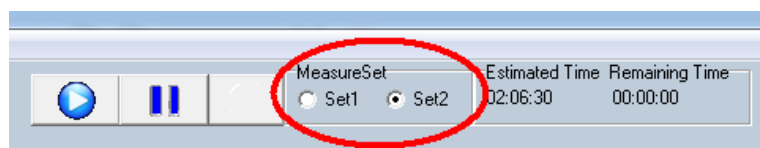

## 18. Final scan / peak re-measurement

Select any peaks from the list by pressing the **Ctrl** button and select it with the left mouse button. Then click the right mouse button and click **Measure**. There are two measurement options. The recommended choice is **Measure (consider drift)**.

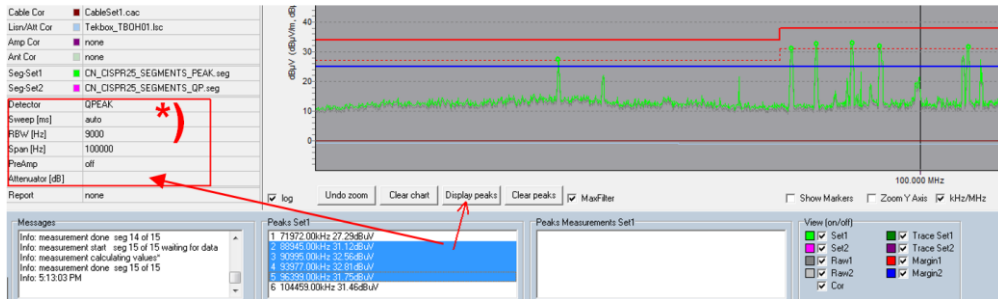

The software will then re-measure, using the selected peaks as center frequency and using the detector, sweep time, RBW, Span and PreAmp settings defined in the control box. This feature is a short cut to make a fast Quasi Peak measurement for selected peaks, instead of making a time-consuming full span QP measurement.

Note that with EMCview V 8.0 and higher, the settings for peak re-measurement are reduced to drift span in order to simplify the user interface and avoid settings, which may result in incorrect measurements. All other settings will be derived from the segment file settings. Refer to the EMCview FAQ document for more detailed information on fast QP measurements.

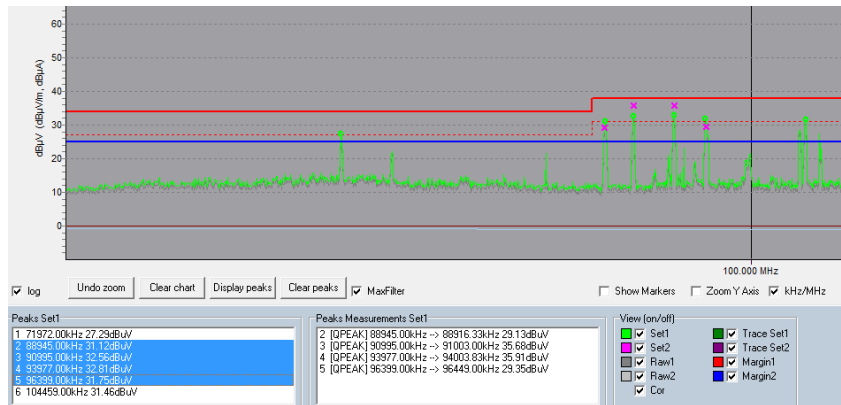

The Peaks Measurements box then displays the results of the fast quasi peak measurement.

In addition, the graph shows a cross at the respective frequency and level.

Consider the span setting of the peak re-measurement, with respect to a potential drift of the peaks. The higher the drift over time (e.g. drift of the frequency of a switched mode regulator), the wider make the span. The software will scan the measurement values of the entire span for the highest peak. Consequently, the frequency of the re-measured peak may deviate from the initial peak frequency. The capability of setting a Span for a peak re-measurement is an essential feature of EMCview, often missed by similar tools.

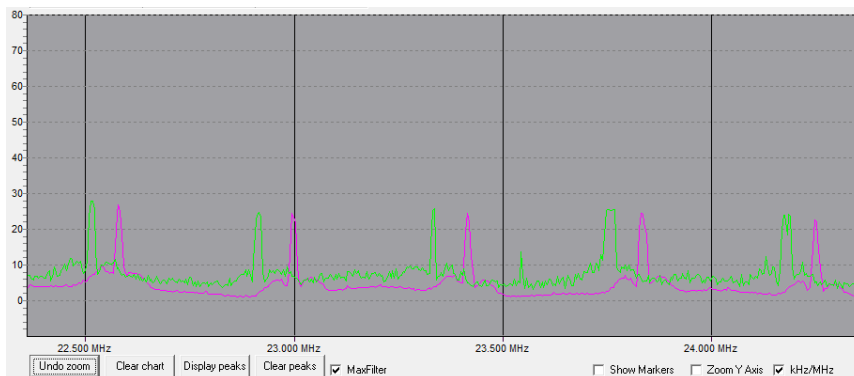

The example above illustrates the purpose of the span setting. Harmonics of a switched mode regulator, which drifted over the time that passed between carrying out the peak measurement (green graph) and the quasi peak measurement (purple graph). If measured at exactly the peak frequencies of the green graph using the option **Measure (ignore drift)**, it would completely miss the signals when re-measuring with quasi peak detector. However, by setting a span of 200 kHz, the quasi peak signal is measured correctly. Use the option **Measure (ignore drift)** only if the spurious are harmonics of a crystal clock.

In the measurement graph, peak markers, which are very close to each other may appear to be at the same frequency, unless zoomed in. Zoomed in, it would look similar as below:



Activate the Max Filter box to get rid of these artefacts.

Note that with EMCview V8.28 or higher, you can enable peak re-measurement to start automatically, after completion of the **Set-1** or **Set-2** scan. However, you have to be aware, that it will re-measure every single peak then.



Furthermore, with EMCview V8.30 and higher, you can enable simultaneous measurement of two graphs with R&S FPC or Siglent analyzers in the **Setup / Option** menu. You then have to switch between **Set-1** or **Set-2** in order to display and re-measure the peaks for the corresponding graph.

## 19. View / hide graphs

The graph window can display several traces:

- Set 1 corrected graph of the measurement defined by Seg-Set1 and Limit1
- Set 2 corrected graph of the measurement defined by Seg-Set1 and Limit1
- Raw 1 raw data of Set1 – no LISN, cable, etc. correction
- Raw 2 raw data of Set2 – no LISN, cable, etc. correction
- Cor correction data of LISN, cable, etc.
- Trace1 Set1 imported data from a previous measurement to overlay for comparison purpose
- Trace1 Set2 imported data from a previous measurement to overlay for comparison purpose
- Trace2 Set1 imported data from a previous measurement to overlay for comparison purpose
- Trace2 Set2 imported data from a previous measurement to overlay for comparison purpose
- Trace3 Set1 imported data from a previous measurement to overlay for comparison purpose
- Trace3 Set2 imported data from a previous measurement to overlay for comparison purpose
- Margin1 margin with respect to Limit1
- Margin2 margin with respect to Limit2
- Segment displays the frequency segments, which are defined in the segment file  
click Segment to enable measurement of selected segments only

Hide or view traces using the tick boxes in the lower right corner of the window.

Configure colors of traces, limit lines and the background of the graph window in the **Setup** menu, **edit colors**.

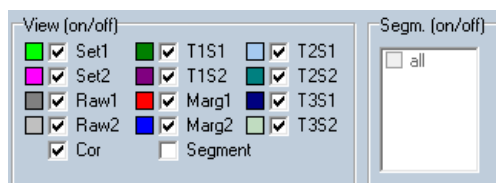

Upon selecting the **Segment** box, the segments defined in the segment file of the current project are displayed on the frequency axis. De-select **all** and then select the segments that you want to re-measure in the segment box in the lower right corner of the EMCview window. In the **Setup / Options** menu, you can select, if you want only the selected and re-measured segments displayed, or if you want to overwrite the initial graph with the newly selected segments. Means, the de-selected segments are kept and displayed as well.

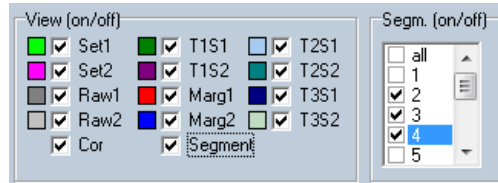

## 20. Zoom graphs

You can zoom or set the boundaries of the graph by entering frequency and amplitude values into the boxes **Chart Start[Hz]**, **Chart Stop[Hz]**, **High[dB $\mu$ V]**, **Low[dB $\mu$ V]**. Press the TAB button or click another box to confirm the entered values. During an ongoing measurement, access to the control box is disabled. Alternatively, you can use the mouse and pull a rectangle in the graph section. When zooming with the mouse, you can **Undo Zoom** with a button under the graph window. You can also switch between **linear** and **logarithmic** frequency axis. When zooming in very deeply, the display may be changed automatically to linear frequency display in order to get a useful grid. Switching to logarithmic frequency axis is not possible then, unless you **Undo Zoom**.

Parameter	Value
Chart Start[Hz]	9000
Chart Stop[Hz]	30000000
High[dB $\mu$ V]	120
Low[dB $\mu$ V]	-11
Limit1	<input checked="" type="checkbox"/> none
Limit2	<input checked="" type="checkbox"/> none
Margin1[dB]	0
Margin2[dB]	0
Cable Cor	<input checked="" type="checkbox"/> none
Lisn/Alt Cor	<input checked="" type="checkbox"/> none
Amp Cor	<input checked="" type="checkbox"/> none
Ant Cor	<input checked="" type="checkbox"/> none
Seg-Set1	<input checked="" type="checkbox"/> none
Seg-Set2	<input checked="" type="checkbox"/> none
Detector	QPEAK
Sweep [ms]	auto
RBW [Hz]	9000
Span [Hz]	200000
PreAmp	off
Attenuator [dB]	10
Report	none

To restrict zooming to the y-axis, click the Y-axis check box.  
In order to use the magnifying glass to check the graph, click **Magnify**.

## 21. Amplitude units

By default, the spectrum analyzer results are taken in dB $\mu$ V. Antenna or current probe measurements need conversion files, taking into account antenna factors or trans-impedance to get the y-axis values displayed in dB $\mu$ V/m or dB $\mu$ A. See the corresponding application notes on the EMCview page for more details. Other than that, units can be selected by ticking the check-boxes next to the lower left corner of the graph window.

## 22. Markers

Clicking **Show Markers** adds the corresponding peak number of the peak list to the graph. Double clicking any marker in the list will place a cross hair.

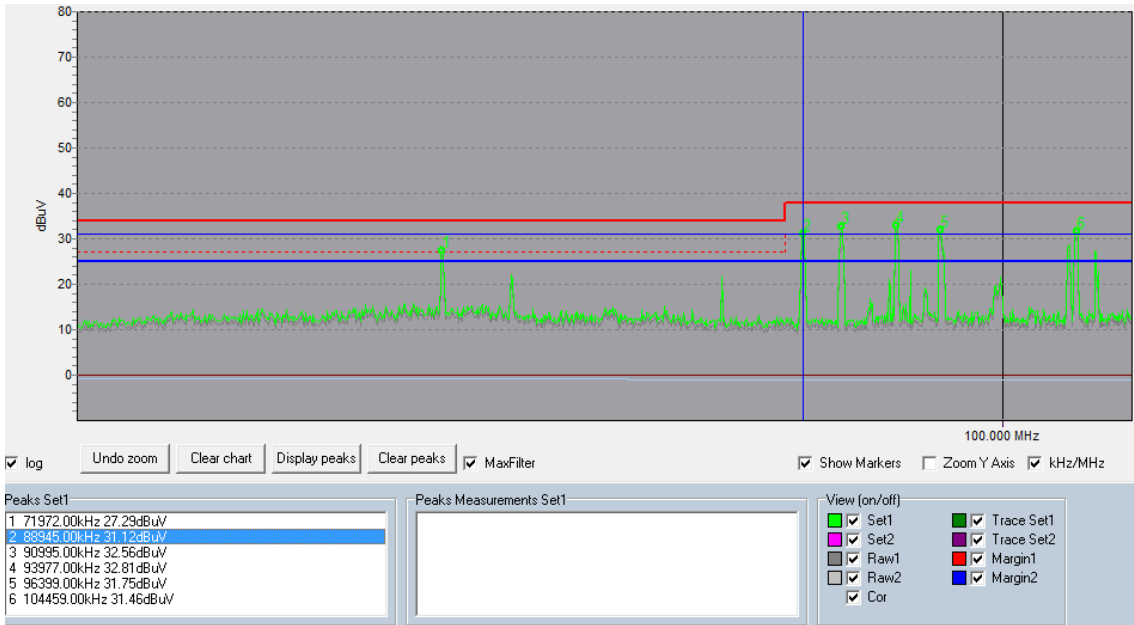

You can also set markers manually:

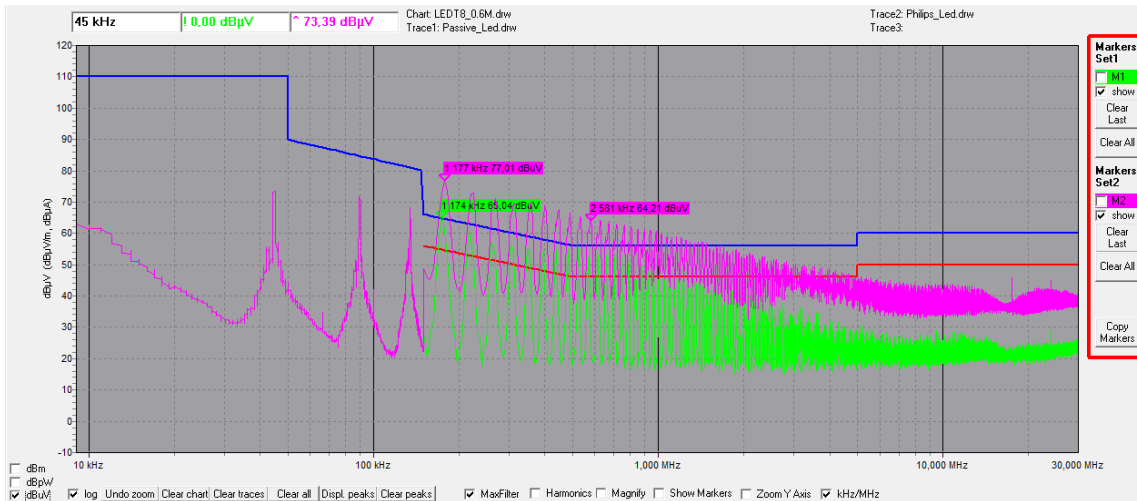

Click Marker on the upper right side of the EMCview window. Click the M1 check box. Thereafter, click at a point of the corresponding graph (Set1) to set a marker. Click the M2 checkbox, if you want to set a marker to the graph measured according the configuration specified for Set2.

If required, manually set markers can be copied into the Peak list for subsequent re-measurement.

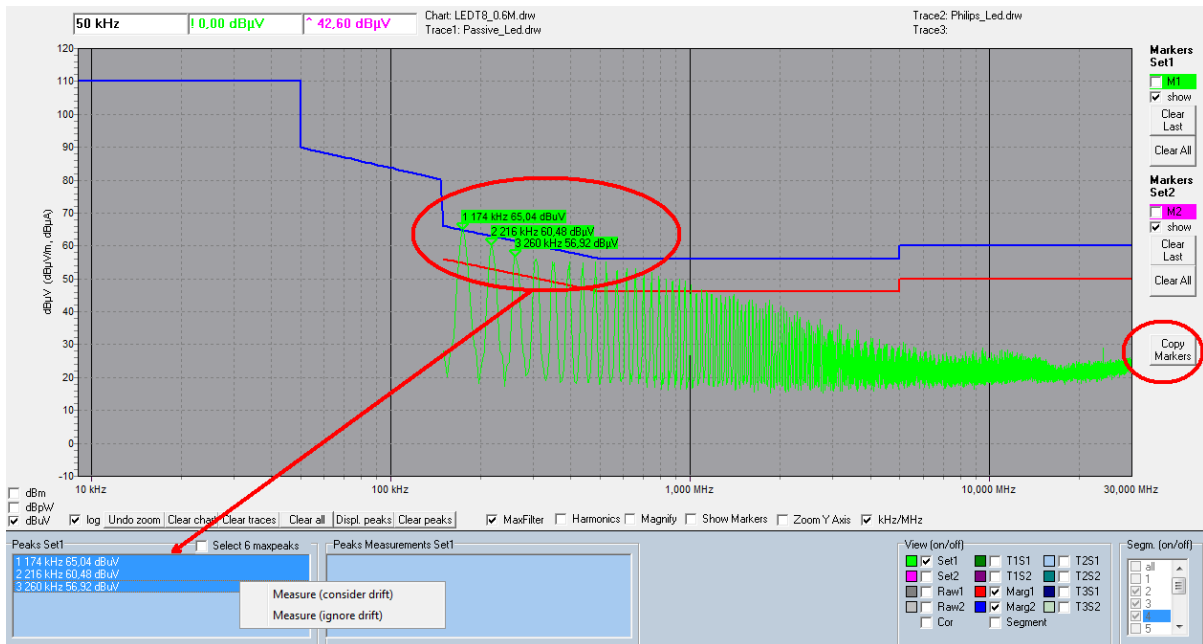

### 23. Labels

If you want to add comments to the graph, click the **Labels** button at the right side of the graph. Click **Set Label** and a text field will appear in the left upper corner of the graph window. Drag the text field to the desired position within the graph. Right click into the text field and a context menu will appear:

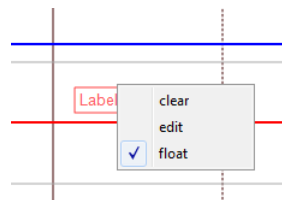

Click **edit** to edit the text. De-activate **float**, if you want to lock the label on its position. The label cannot be dragged anymore thereafter. By default, the text field has a frame. If you want to remove the frame, enter menu **Setup / Options** and set it to transparent. If you want to change the font size of the labels, edit the **emcview.ini** file that you can find in the installation folder of EMCview. Change the **TextSize1** parameter to the desired value. The color of the labels can be changed in the **Setup / Edit Colors** menu of EMCview. Note that you can only change the color of all labels, but not change colors of individual labels.

Within Labels, you can also set a **Time Stamp** Label and a **Project Stamp** label. Any time, the **TimeStamp** button is clicked, it will update date and time. In **Setup / Options** menu, you can set the time stamp label being updated, any time you press the **Copy Clipbd** button.

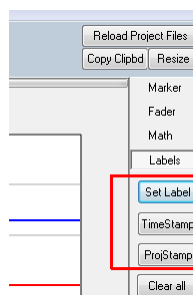

## 24. Options

In menu **Setup / Options** you can set various preferences:

**Path / Out:** by default, all files are saved in the EMCview\Out directory. Here you can change your preferred default output directory.

**Misc / Enable dialog box to conform closing EMCview:** Close EMCview immediately or upon confirming in a dialog box

**Misc / Load last project:** Launch EMCview with the project file used when last exiting EMCview

**Misc / Show TG box to enable TG during RF measurement sweep:** In preparation of a future feature to create amplitude correction files using the tracking generator of the analyzer

**Misc / Enable sweep step size in %:** Add a selection box in the generator feature to select sweep step size either in Hz or in %

**Misc / Report marked peaks only:** In order to avoid an excessively long peak list in the report file, the listed peaks can be limited to selected (marked) peaks from the peaks list

**Misc / Show full names of loaded charts and traces:** When loading charts or traces, they will be displayed on top of the graph window. If the file names are excessively long and exceed the available display space, they will be cropped to a suitable length.

**Misc / Keep old segments, when re-measuring selected segments:** When making selective measurements, keep results of previous measurements for skipped segments instead of connecting it with a straight line.

**Misc / Show checkbox for MaxHold and Repeat measurement:** This adds two checkboxes below to the measurement button for repetitive scanning and Max Hold.

**Misc / Show checkbox for consecutive measurement of both sets:** This adds a checkbox next to the measurement button to choose to automatically run Set2 after Set1 has finished.

**Misc / Monitor SCPI communication link:** Indicates in the status line, if the communication link between PC and analyzer is interrupted (green hook/red x).

**Misc / Show VISA errors:** Displays Visa error messages in a pop up window

**Misc / Enable simultaneous measurement for two traces:** R&S FPC models and Siglent analyzers can simultaneously measure two traces (**Set-1** and **Set-2**). If **Set-1** is active, the second trace will use all settings configured in the segment file of **Set-1**, except the detector setting, which will be based on the configuration in segment file of **Set-2** and vice versa. Consequently, if the standard limits cover different frequency ranges for the two detectors, select **Set-x** according to the segment file with the wider frequency range.

**RealTimeMode:** Enable real-time measurements. This feature requires an EMCview PRO license and works only with Siglent and Rigol spectrum analyzers, which support real-time measurement.

**Styles:** Selection of various Windows styles; default Slate Classico

**Labels / Draw labels transparent:** Removes frame and background of the label text boxes

**Labels / Update time stamp when copying to clipboard:** Updates the time stamp label, when the graph window is copied to the clip board

**Workarounds:** workarounds for bugs of spectrum analyzers with older firmware versions. If you miss the result of the measurement in the graph window, change the Chart High and Chart Low levels in the configuration section to +/- 200 dB $\mu$ V. If the graph appears with 107 dB offset, you can apply the workaround or better update the FW of the spectrum analyzer.

Another workaround lets you shift the right window border, in case that the EMCview window is cropped at the right side. This may be required for Laptops with tiny displays.

## 25. Fader

The “fader” is a feature to cancel ambient noise when measurements are carried out in a non-shielded setup. It needs to be mentioned upfront, that it is no alternative to measurements in shielded chambers or tents. Main reason for implementing the fader feature was repeated customer request.

The fader is based on making a measurement of the ambient noise, with the DUT not powered and then subtracting the ambient noise from a consecutive measurement, with the DUT powered.

However, ambient noise is hardly ever static. Cellular radio signals are highly dynamic both in frequency and amplitude. Broadcast stations create ambient noise with static frequency, however they drift in amplitude. Subtracting such signals will not cancel completely or may result in negative spikes, if their amplitude does

not remain constant, but decrease or increase in the time between taking the un-powered measurement and the powered measurement.

Consequently the fader does not take the entire ambient noise spectrum, but gives the user the capability to select portions of the noise spectrum that he wants to subtract.

To use the fader, first take a measurement with the DUT not being powered. Then click the **Fader** button at the right side of the graph window and activate the **fade** box. Then left click the mouse to pull a window across the noise that you want to get subtracted when you do a powered measurement.



Activate the **Cor** box to see the resulting correction curve.

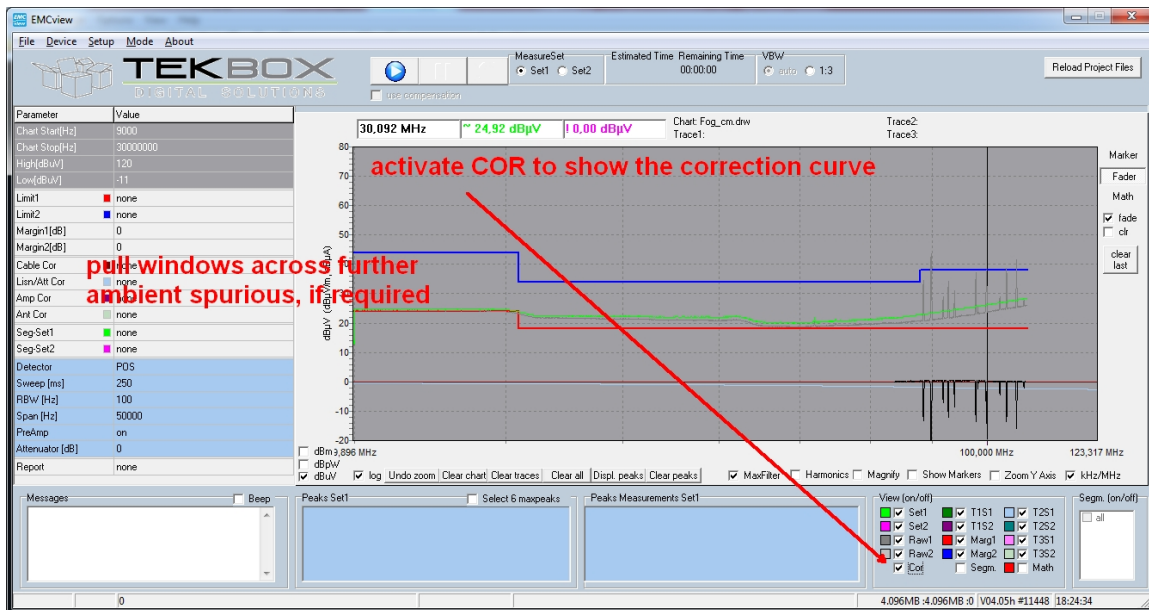

Repeat this process for other noise spurious, if required.





Next save the correction curve in **File, Utilities, Save Zero Compensation**.

In order to apply the correction curve to the powered measurement, load the correction curve in **File, Utilities, Load Zero Compensation**. Then click the box **use compensation (fader compensation)** located under the **Play** button.

Then start another measurement run, with the DUT being powered. The correction curve will then immediately be applied to this measurement.

As mentioned – don't expect miracles from this feature. A perfect cancellation will only be achieved for ambient noise signals that remained perfectly constant with respect to frequency and amplitude. Also be aware, that any DUT noise hidden under the ambient noise will not be recovered.

## 26. Math

“Math” is a feature to add, subtract, multiply or divide traces. The traces need to be loaded into EMCview before being able to carry out mathematical operations.

Click the **Math** button located right to the graph window. Then select the traces, select the mathematical operation and click the **Calc** button to get the result displayed in the graph window. In order to view the resulting graph, activate the **Math** button in the **View (on/off)** window.

If you take for example conducted noise measurements of the positive and negative supply line and want to merge it to a worst case graph, load the traces and use the **MAX** operation.

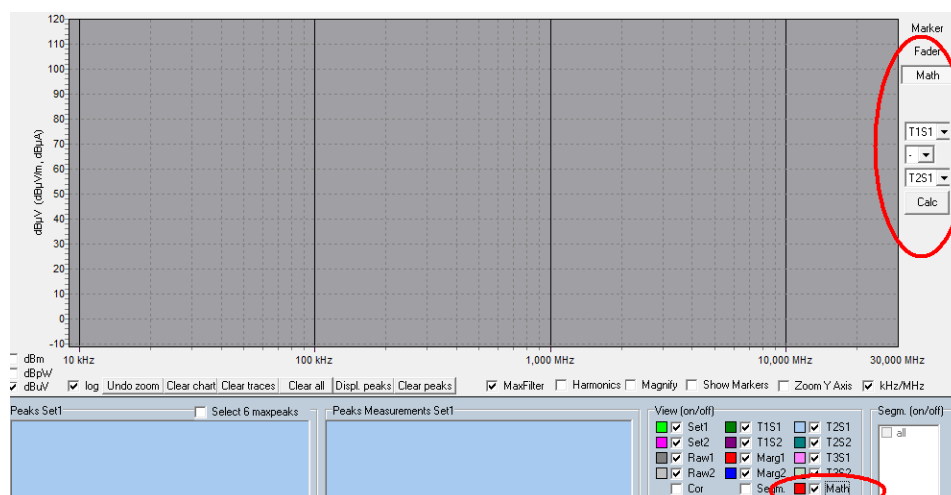

## 27. Saving graphs and measurement results

Save data in **File** menu, **Utilities**, **Save Chart**. The chart (graph) of any measurement can be reloaded into EMCview clicking **Load Chart**. Clicking Load Chart overwrites any graph present on the screen. Reload and overlay older measurements to a fresh measurement for comparison purpose by clicking **Load Reference Trace** in the same menu. This feature adds (overlays) one or two more graphs to the existing measurement or chart. Restarting a measurement will clear the graph of the previous measurement, but not affect the **Reference Trace**.

In order to bring any of the reference traces to the foreground, click at the line listing the trace file. Click at the text again to bring it to the background.

Click **Save as WMF File** to save chart screen shots.

Click **Save as CSV File** to save the measurement result as table.

You can **save peak lists** as text file, right clicking in the peak window and selecting **Save to File** in the context menu.

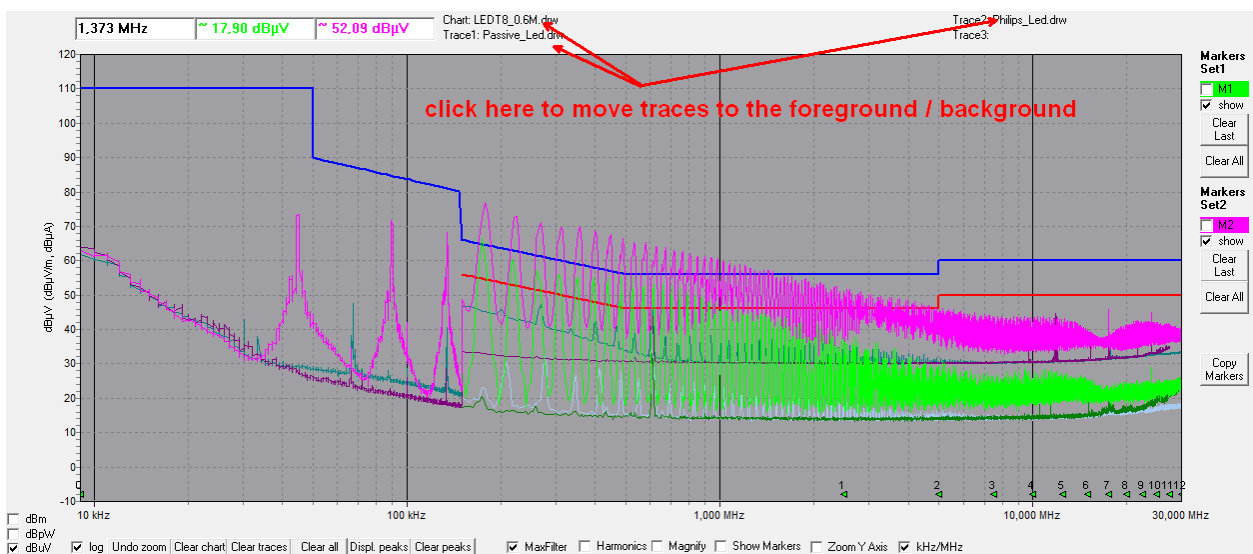

Charts are always saved including the amplitude correction data. If you figure out, that you applied wrong correction files, after completing a measurement, you can save the chart and then reload it as raw data and select different amplitude correction files.

With EMCview V8.12, meta data is added when saving charts. You can restore the entire set up of EMCview of the point you carried out your measurement and saved the chart. This not only includes the set-up, chart and correction data, but also any trace, which was loaded when saving the chart. Load the chart and then right click at the chart string displayed on top of the graph window, after loading the chart:

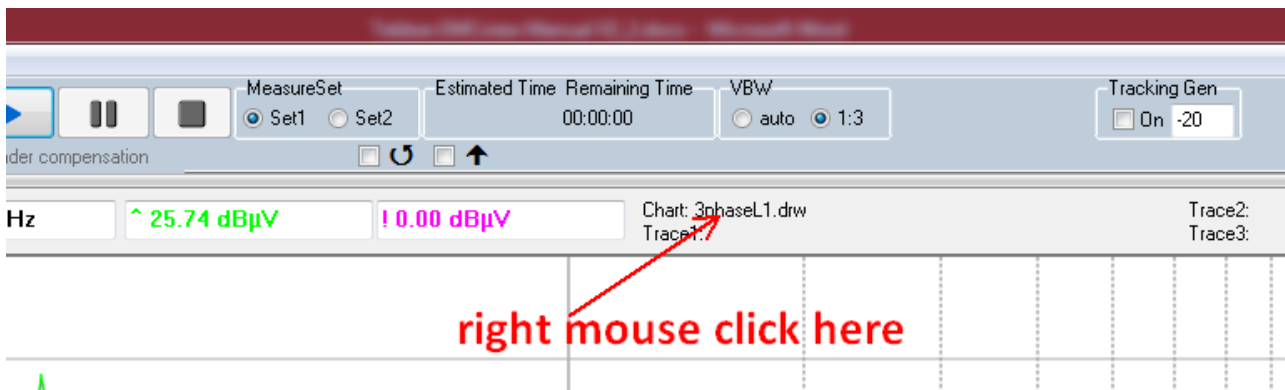

After right clicking, following window will pop up:

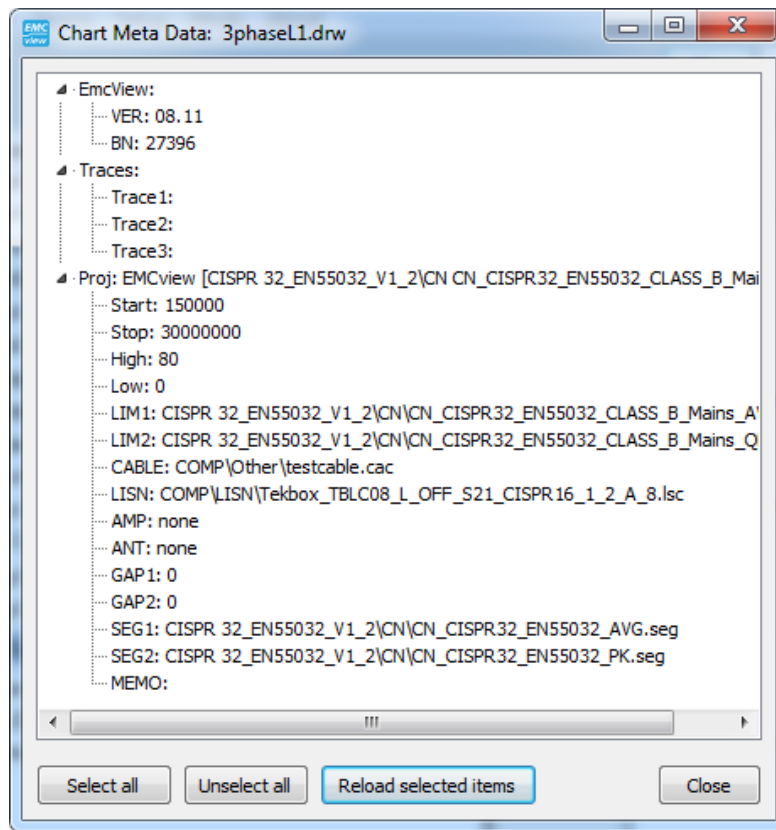

Click **Select all** and **Reload selected items**, if you want to restore the entire set up or make a selection by clicking any of the lines. Note that restoring only works correctly, if all involved files are still present in its original location.

## 28. Control of additional equipment with EMCview

With EMCview V5.48 or higher, commands for ASCII controllable devices can be added to the segment files. You can use a device such as KMTronic 4UCRB Relay Controller to switch coaxial antenna relays or external attenuators.

Go to menu DEVICE to connect to the relay controller:

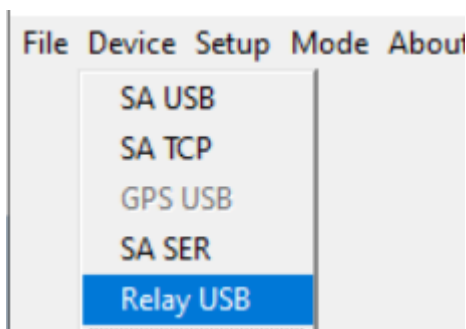

Next select the COM port and set up the parameters for the serial interface of the relay controller or any other serial device. Establish the connection and optionally transmit a string for testing/validation:

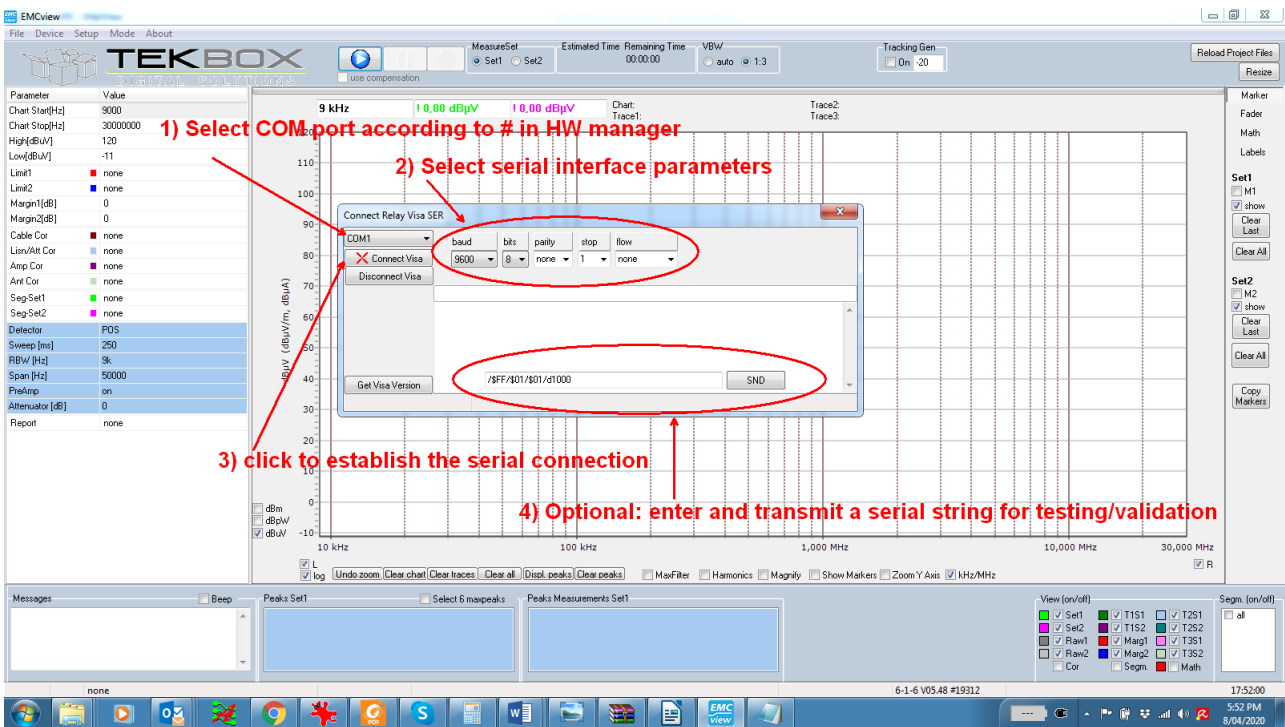

In order to automatically transmit test strings, they need to be entered into the desired segment file. You can add two serial command strings to each segment. Command SCPI\_A will be executed before the sweep of the corresponding segment. Command SCPI\_B will be executed after the sweep of the corresponding segment.

Example: Segment file with commands for the KMTronic 4UCRB Relay Controller

```
[Application]
Software=TekBox RP-W32-D10
Version=Release
Date=18.02.2020 13:52:22
[General]
Name=CN_CISPR15_SEGMENTS_AUG_relais_seg
[Data]
FRQa__1=150000
FRQb__1=2500000
Bw___1=9000
Sweep_1=25000
Att___1=10
PreAmp1=off
Detector1=UAV
SCPI_A_1=/$FF/$01/$01/d1000
SCPI_B_1=/$FF/$01/$00/d1000
FRQa__2=2500000
FRQb__2=5000000
Bw___2=9000
Sweep_2=25000
Att___2=10
PreAmp2=off
Detector2=UAV
```

SCPI\_A\_x: command sent at the beginning of the segment

SCPI\_B\_x: command sent at the end of the segment

Explanation:

SCPI\_A\_x with x being the segment number; command sent at the beginning of the segment

**SCPI\_B\_x** with x being the segment number; command sent at the end of the segment

**SCPI\_B\_x** is optional. A single command at the beginning of the segments would be sufficient to turn ON/OFF a relay.

**/\$FF/\$01/\$01:** serial string to turn on output 1 of the KMTronic 4UCRB Relay Controller. It will send the characters FF 01 01. This string is not EMCview specific. Its syntax has to be chosen according to the manual of the corresponding device. FF 01 01 means turn ON Output 1 of the 4UCRB. EMCview will send whatever string is entered in this place.

**/d1000:** wait 1000 ms before starting the sweep. Maximum value: 9999 ms

Special control commands can be entered as **/\$XX** (upper case, always 2 characters)

Example:

**/\$0A** LF, Line Feed (not /\$0a)

**/\$0D** CR, Carriage Return (not /\$cr)

## 29. Using RF current probe measurements to extrapolate to radiated E-field strength

Signal- and power supply cables carrying conducted noise act as antennas and consequently cause radiated emissions.

Henry Ott and Clayton Paul outlined a method to convert RF current probe measurements into electric field strength radiated from cables carrying RF currents. It is a derivation/simplification of the full treatment outlined in "Antenna Theory – Analysis and Design" (C. Balanis).

This application note is based on an excellent article on the website of Andy Eadie from EMC FASTPASS. The application note explains how this method can be applied, using Tekbox EMCview software. It automatically creates a graph of radiated emissions, converting a common mode current conducted noise measurement carried out with a RF current probe and a spectrum analyzer.

Andy Eadie's article can be found here:

<https://emcfastpass.com/current-probe-e-field-emi-testing/>

### "The Formula"

$$E = \frac{4\pi \cdot 10^{-7}(f \cdot I \cdot L)\sin\theta}{r}$$

E = electric field strength [V/m]

f = frequency [Hz]

I = CM current [A]

L = cable length [m]

r = measurement distance [m]

$\Theta = \pi/2$

According to Andy Eadie's article, this formula delivers a very accurate result up until approximately 200 MHz with a 1m cable.

The Tekbox application note *AN\_ RF current to electric field strength extrapolation* shows two methods how to calculate and display the E-field using EMCview. Refer to this document for detailed instructions.

## 30. EN 61000-4-20 correlation

EN 61000-4-20 specifies how to correlate radiated emission measured in (G)TEM-cells with OATS measurements. The EN61000-4-20 correlation algorithm requires separate scans for the three main orthogonal orientations of the EUT. After measuring the EUT and saving the results as chart files, load the three charts as reference traces (Trace 1, Trace 2, Trace 3).

Click the EN61000-4-20 button at the right side of the window:

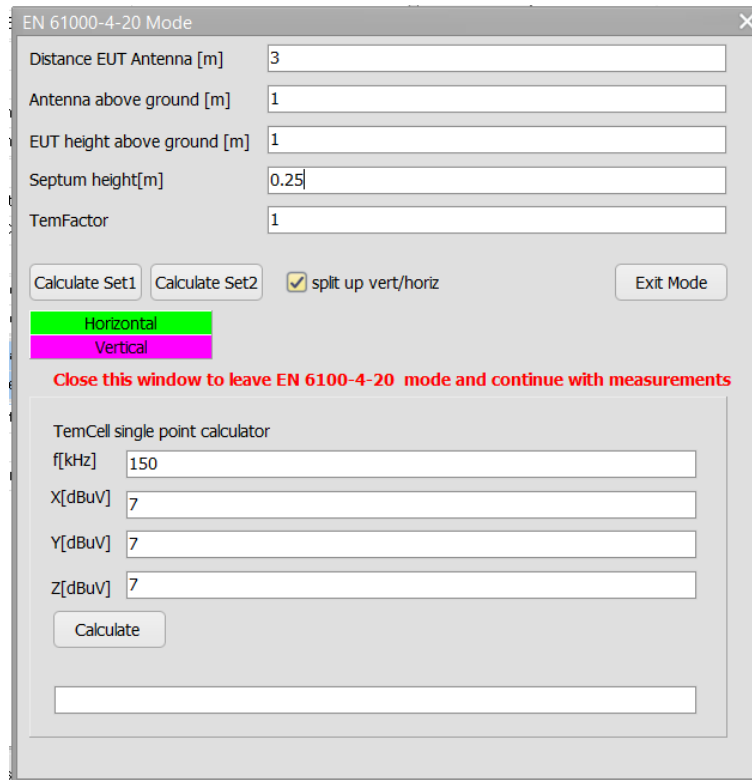

Next click the **Calculate Set1** button to calculate the correlated OATS result:

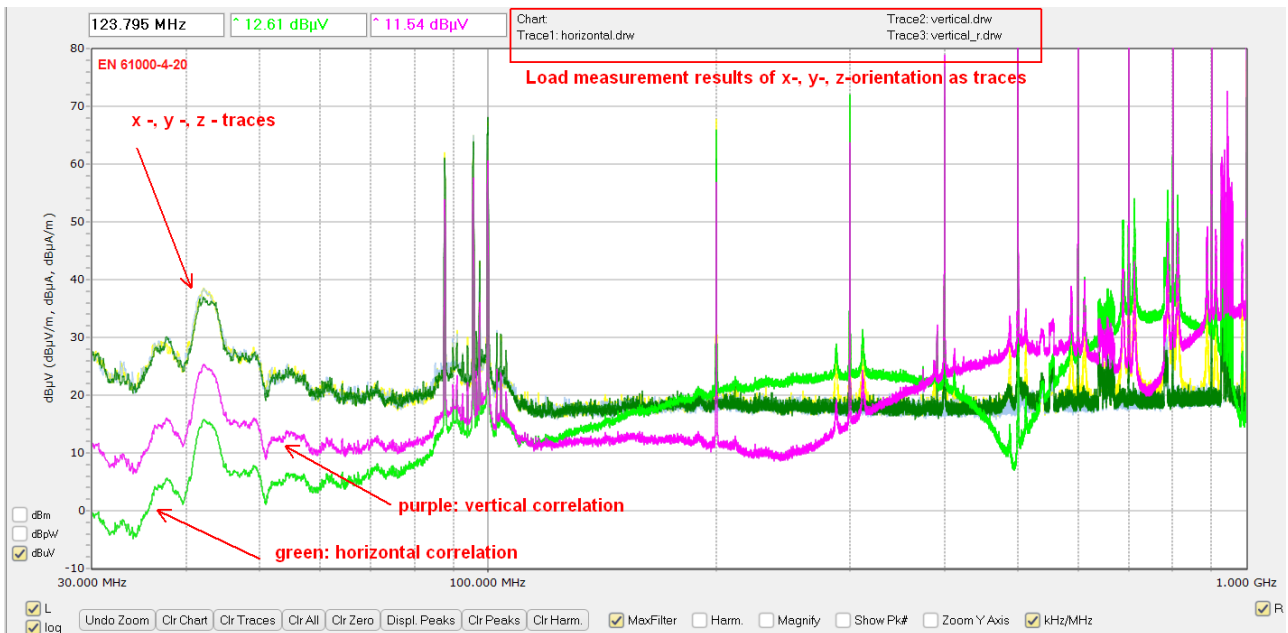

The correlation result appears as two additional charts. These charts can be processed same as any other chart, however, no peak-remeasurements can be carried out.

“EN 61000-4-20” indicates that EMCview is in EN 61000-4-20-mode. The measurement buttons cannot be activated. In order to exit the EN 61000-4-6 – mode, click at the EN 61000-4-6 button and press **Exit**.

Refer to the TEM-cell FAQ document, chapter 6, for a detailed description of the EN61000-4-20 correlation.

### 31. Real time measurements

Starting with EMCview version 8.42, the license variant EMCview PRO, offers real time analysis capability and advanced conducted immunity testing features. The customer can select between a standard EMCview license or EMCview PRO. Users with a standard EMCview license have the option to upgrade to EMCview Pro.

Real time analysis can be activated in menu SETUP, OPTIONS, RealTimeMode.

The RealTimeMode feature supports analyzers of Rigol and Siglent.

EMCview version 8.42 supports 10 MHz, 20 MHz and 40 MHz real-time bandwidth for Rigol analyzers and 25 MHz, 40 MHz real-time bandwidth for Siglent analyzers.

In the OPTIONS window, enable real-time mode, select the analyzer brand and press APPLY, EXIT:

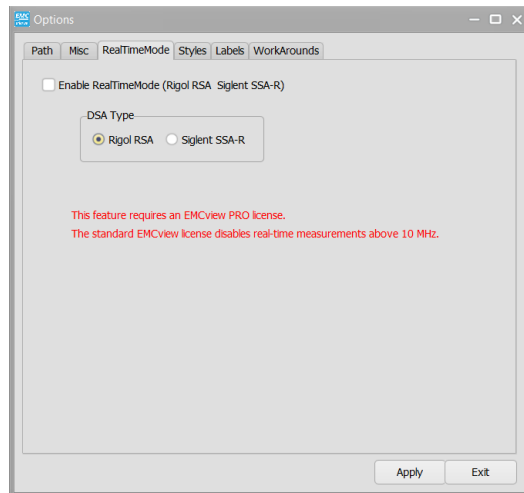

The start button for the measurement will indicate the activation for real-time mode. The configuration section will show two additional segment files, which are used for real-time mode measurements:

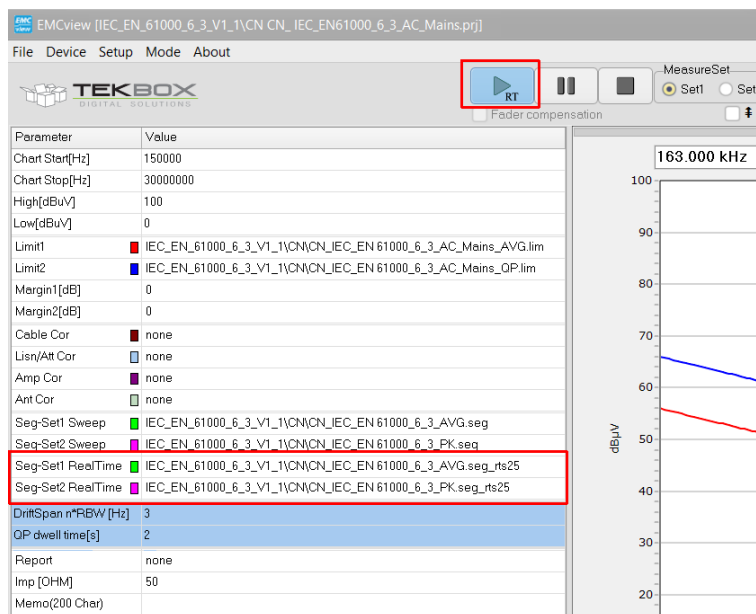

In the screenshot above, the extension of the segment file \*.seg\_rts25 indicates 25 MHz real-time bandwidth for Siglent analyzers. Similarly, the extension \*.seg\_rtr10 (\*.seg\_rtr20, \*.seg\_rtr40) would indicate 10 MHz (30 MHz, 40 MHz) real-time bandwidth for Rigol analyzers. In the implementation of EMCview V8.42, the **SETUP** menu does not offer a selection other than the analyzer brand. In order to select 20 MHz or 40 MHz RTBW for Rigol models, the corresponding segment files must be loaded manually:

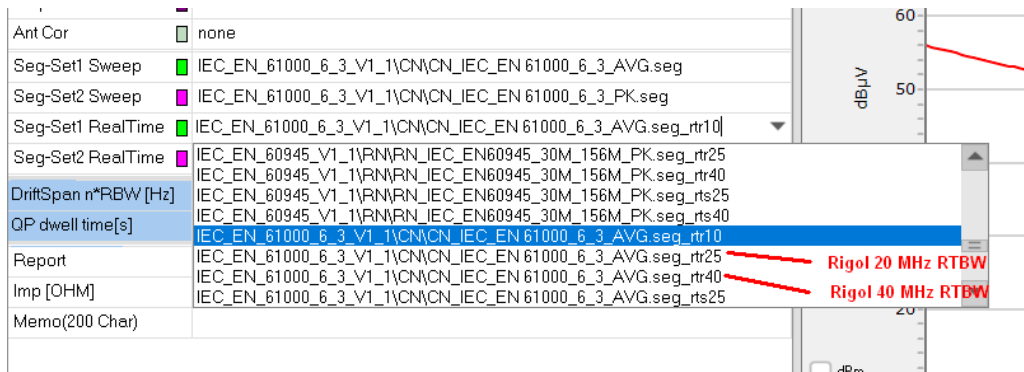

Similarly, proceed for loading Siglent 40 MHz RTBW segment file.

**Limitations of Real Time Mode with respect to CISPR 16 compliance**

The implementation of real time mode on the analyzer does not permit the selection of CISPR filters and bandwidths. EMCview RTBW segment files configure frequency spans and acquisition times in order to achieve a resolution bandwidth as close as possible to the corresponding CISPR bandwidths. Furthermore, available detectors in real-time mode are limited. There is no QP detector available in real-time mode. Furthermore, the results of the average detector may deviate up to 10 dB compared to the sweep mode measurement, in case of broadband noise. In contrary, the results of the peak detector measurement in real-time mode comes pretty close to the results in sweep mode.

The currently implemented real-time segment files support the frequency range from 9 kHz to 1 GHz. Above 1 GHz, a RTBW of 10 MHz would require 100 segments/GHz. The advantage of the fast measurement time of a single segment is nullified by the processing time required for downloading data and configuring and starting consecutive segments. Swept measurements above 1 GHz have segment files with 300 MHz span and 30 seconds sweep time.

Real-time mode is significantly speeding up emission measurements, which is a great advantage when tracking modifications for relative improvements during design optimization. However, final measurements should be carried out in sweep mode for confidence reasons.

**Real-time segment files**

Below an example for a Siglent analyzer with 25 MHz RTBW. The parameters in the red boxes are relevant for real-time mode, whereas the parameters in the green boxes are ignored. In case of Siglent analyzers, the Realtime resolution bandwidth RT\_BWx= is ignored as well. The real-time resolution bandwidth results from the settings for the span Freqa\_x and Freqb\_x and the setting for the acquisition time. These were derived by entering it manually and tuning it until the desired resolution bandwidth could be achieved.

```

CN_IEC_EN_61000_6_3_PK.seg_rts25 - Editor
Datei Bearbeiten Ansicht

[Application]
Software=TekBox RP-W32-D11
Version=Release
Date=28/12/2022 16:25:08
[General]
Name=CN_IEC_EN_61000_6_3_PK.seg_rts25
[Data]
FRQa_1=150000
FRQb_1=3900000
BW_1=9000
Sweep_1=25000
Att_1=10
PreAmp1=off
Detector1=POSPEAK
RT_BW1=
RT_AQT1=35
RT_WIN1=KATS
FRQa_2=3900000
FRQb_2=7650000
BW_2=9000
Sweep_2=25000
Att_2=10
PreAmp2=off
    
```



## 32. Conducted immunity testing

Starting with EMCview version 8.42, the license variant EMCview PRO, offers real time analysis capability and conducted immunity testing features. The customer can select between a standard EMCview license or EMCview PRO. Users with a standard EMCview license have the option to upgrade to EMCview Pro. EMCview PRO supports four conducted immunity modes. Two modes are used for immunity measurements using CDNs or BCI clamps according to EN 61000-4-6 and the other two modes cover immunity testing with BCI clamps according to ISO 11452-4.

### 32.1 AM versus CW

Most immunity tests use an 1kHz, 80% AM modulated disturbance signal. Furthermore, stress levels are specified as RMS levels. When using a signal generator and switching from CW to AM, the peak amplitude of the AM modulated signal will be automatically increased 5.1 dB compared to CW in order to keep the RMS level constant. In case of the pre-compliance setups where EMCview controls the tracking generator of a spectrum analyzer connected to a Tekbox modulated amplifier, the situation is different. At constant TG level, when turning on the internal modulator of the amplifier, the peak level of the AM modulated signal remains at the same value as for CW. Consequently, the TG level needs to be increased 5.1 dB to achieve the desired RMS level of the AM modulated signal. This is also necessary, because not every of the supported spectrum analyzer models is equipped with a RMS detector. Consequently, all analyzer measurements use the peak detector. AM levels show the peak amplitudes of the AM modulated signal. The corresponding RMS level is 5.1 dB lower.

### 32.2 EN 61000-4-6, CDN

EMCview PRO enables “Immunity” in menu **Mode**

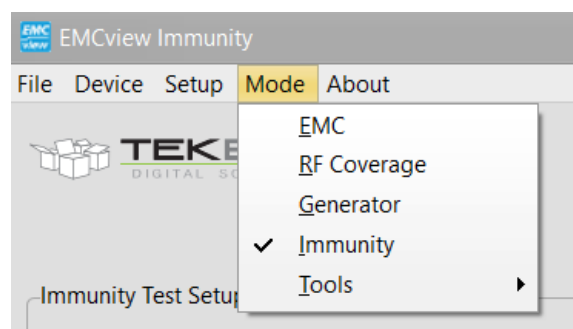

Below a screenshot of the EN 61000-4-6 immunity feature for testing with CDN. The immunity test is a two-step process. First, the setup needs to be calibrated (left screen - section). Next, the EUT and supply need to be connected and the immunity test needs to be carried out (right screen - section).

#### **Immunity Calibration:**

Set up the equipment as depicted in the screen-shot. In the **calibration setup calculator** window select the desired stress level. The calculator will then display the required output power of the amplifier and the corresponding power at the RF input of the spectrum analyzer depending on the involved attenuators. This level will be transferred into the parameter list of the **Immunity Test Setup Calibration** window.

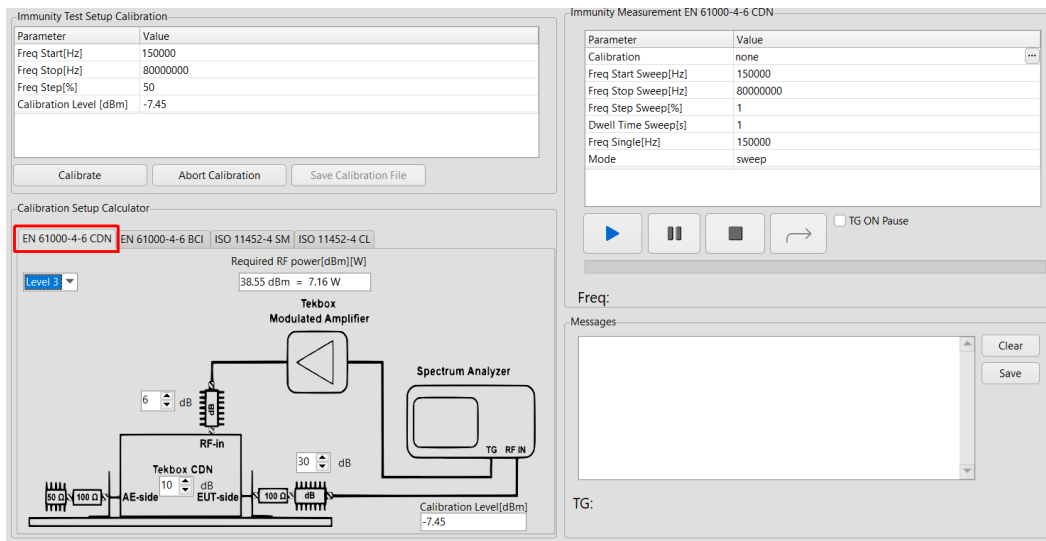

Next, set the desired frequency range and frequency steps in the **Immunity Test Setup Calibration** window and press the **Calibrate** button. During calibration, the tracking generator frequency will be stepped across the configured frequency range and the tracking generator level will be set in order to achieve the configured stress voltage (test level) across the entire frequency range. Upon completion of the sweep, save the resulting calibration file. The calibration file contains a table with frequency points and their corresponding tracking generator level. This table will be used during the actual immunity test to look up the tracking generator level and set it in order to compensate for the frequency response of the tracking generator, power amplifier and CDN. The resulting accuracy is  $\pm 1$  dB, as the amplitude resolution of the tracking generator is limited to 1 dB. The calibration and test will always use an AM modulated signal. The displayed calibration level is the AM peak power, as many of the supported spectrum analyzers don't have an RMS detector.

If the desired stress voltage cannot be achieved at one or more frequency points, EMCview will display a warning message that it cannot achieve the target level. The tracking generator output level will be set to the maximum value of 0 dBm then. Nevertheless, the calibration file can be used, but keep in mind that the stress voltage at the corresponding frequencies will be lower than targeted. You may reduce the 6 dB attenuator to 3 dB as a workaround or use a more powerful modulated amplifier, such as the TBMDA-CDN25.

It also may happen, that you get a warning message that the stress voltage is too high. The tracking generator will be set to the minimum possible value then. This issue may happen, if the stress voltage is set to Level 1 and the analyzer cannot set a TG level lower than -20 dBm. Connect a 10 dB attenuator to the TG output of the analyzer to fix this issue.

**Immunity Test:**

Set up the equipment as depicted below:

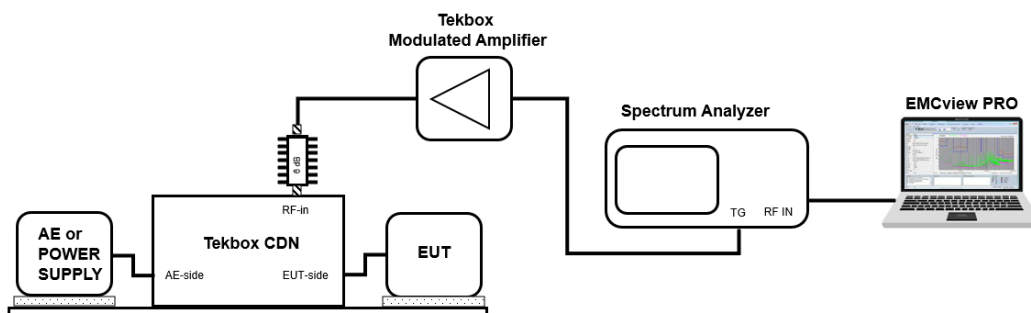

In order to run the immunity test, click the **Calibration** box in the **Immunity Measurement** window. Select the calibration file, configure the remaining parameters as desired and click the **start** button. Upon observing an immunity issue, the sweep can be paused. The sweep can be continued by clicking the **pause** button again. The direction of the sweep can be reversed, by clicking the **arrow** button.

### 32.3 EN 61000-4-6, BCI

#### Immunity Calibration:

Click at the EN 61000-4-6 BCI tab, set up the equipment as depicted and proceed same as described for the CDN in the previous chapter. After calibration, click the **Save Calibration file** button. The test is carried out with AM and the displayed level corresponds with the AM peak amplitude.

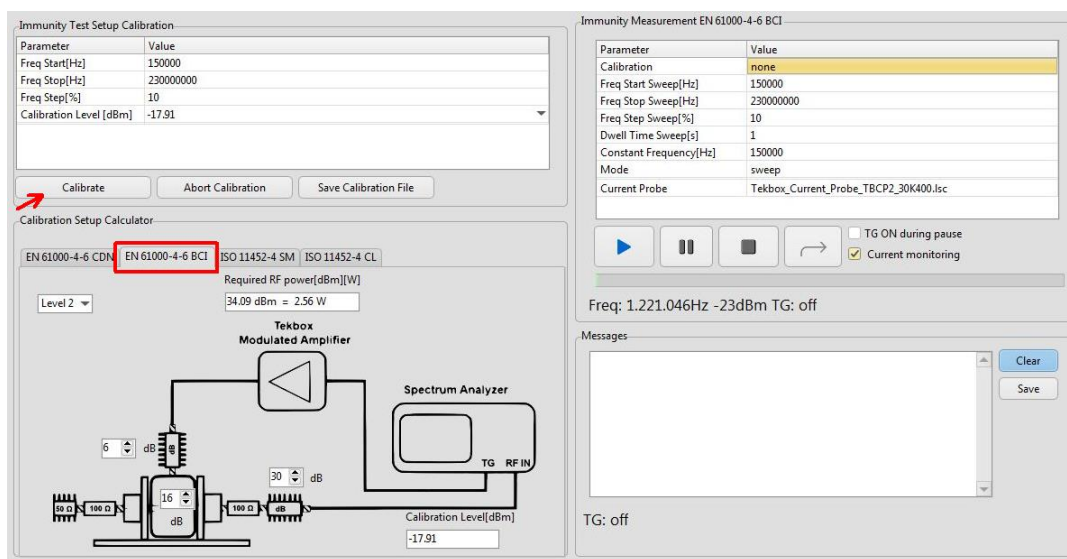

#### Immunity Test:

Load the calibration file and press the PLAY button to start the immunity test. Optionally, a current probe can be inserted to monitor the injected current during testing. The measured current is displayed in the message box.

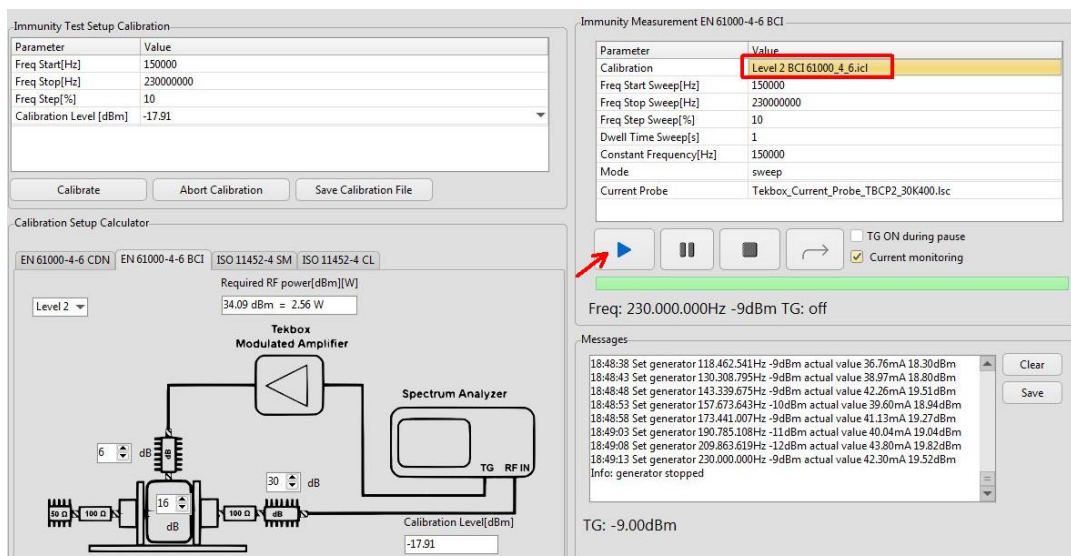

Set up the equipment as depicted below and proceed same as described for the CDN in the previous chapter.

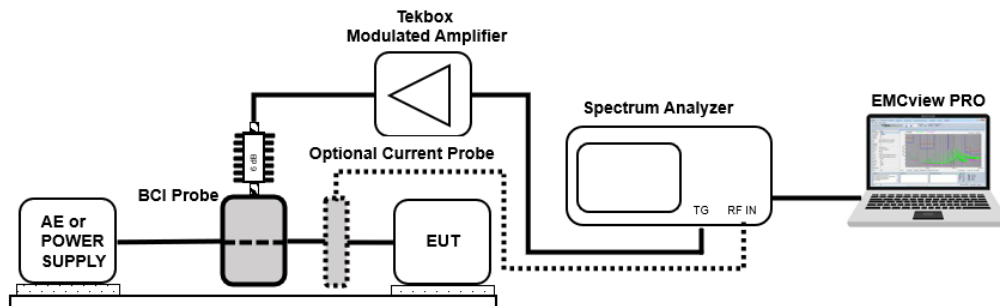

### 32.4 ISO 11452-4, BCI, Substitution Method

According to ISO 11452-4, the immunity test can be performed as a "Closed Loop" test, which eliminates the need for a separate calibration, or applying the "Substitution Method", which requires a calibration process. While the stress levels provided in EN 61000-4-20 are expressed in terms of voltage, the stress levels specified in ISO 11452-4 are expressed in terms of injected current. The Substitution Method uses a two-step calibration procedure to control the injected current. To attain the intended injected current, the required TG level must first be determined. Subsequently, the TG levels acquired in step 1 are set and the corresponding RF forward power is measured. The forward power levels vs. frequency that are necessary to generate the intended injected current are contained in the calibration file that is produced. Either CW or AM signals may be required under the standard. Adjust the checkbox appropriately. The injected current follows the ramp specified in the standard.

#### Calibration step 1:

Set up the equipment as shown below. In EMCview, select ISO 11452-4 SM, SM current calibration. Set the desired stress current level. Select the modulation, frequency range, frequency step size and select the correction file of the involved VSWR bridge or directional coupler.

Next press the calibrate button.

EMCview PRO adjusts the TG level to obtain the specified stress current for each frequency point over the selected frequency range. The calibration produces a calibration file that contains the tracking generator

levels vs frequency for the corresponding stress level. The Message-box will inform you, when the calibration is finished. Next press the **Save Calibration file** button to save the data in a temporary file. With the TBMDA-BCI25 25 Watt amplifier, Level IV (200mA) can be achieved in CW mode. Level II (100 mA) can be achieved in AM mode.

**Substitution method, calibration, step 1**

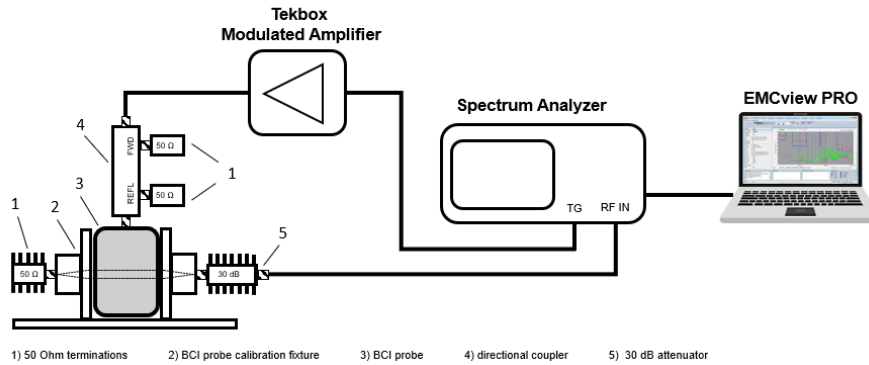

**Calibration step 2:**

**Immunity Test Setup Calibration**

Parameter	Value
Freq Start[Hz]	1000000
Freq Stop[Hz]	400000000
Freq Step[%]	10
Calibration Level [dBm]	2.09
VSWR Bridge	TBSWR_200K500_Coupling.amp

**Immunity Measurement ISO 11452-4 SM**

Parameter	Value
Calibration	none
Freq Start Sweep[Hz]	1000000
Freq Stop Sweep[Hz]	400000000
Freq Step Sweep[%]	1
Dwell Time Sweep[s]	1
Freq Single[Hz]	1000000
Mode	sweep

TG ON during pause

**Calibration Setup Calculator**

Level II SM FWD PWR Measurement

RMS [dBm]    Peak [dBm]  
-3.01        2.09

Set up the equipment as shown below.

Next press the **calibrate** button.

The tracking generator level is set according to the data contained in the temporary calibration file that was created in step 1. The equivalent RF forward power is measured for each frequency point. The Message-box will inform you, when the calibration is finished. Next press the **Save Calibration File** button to save the data in a file.

The calibration file contains the required RF forward power value to achieve the specified injected current for each frequency point.

Substitution method, calibration, step 2

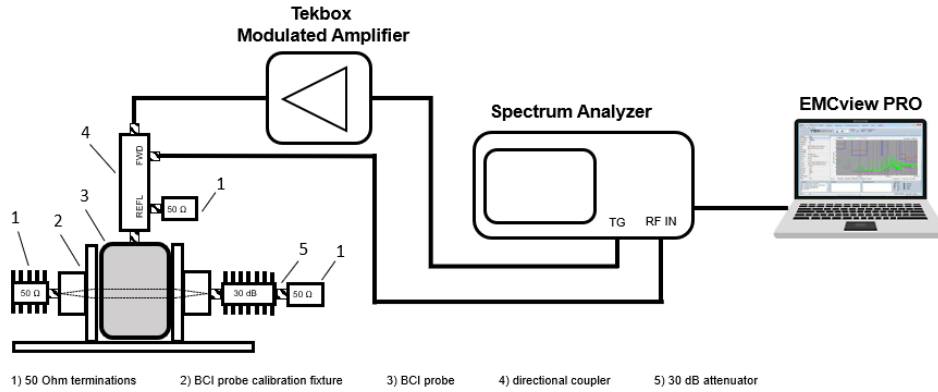

Step 3, actual immunity test:

**Immunity Test Setup Calibration**

Parameter	Value
Freq Start[Hz]	1000000
Freq Stop[Hz]	400000000
Freq Step[%]	10
Calibration Level [dBm]	2.09
VSWR Bridge	TBSWR_200K500_Coupling_amp

Calibrate    Abort Calibration    Save Calibration File

**Calibration Setup Calculator**

EN 61000-4-6 CDN    EN 61000-4-6 BCI    ISO 11452-4 SM    ISO 11452-4 CL

Level II    Substitution method, calibration, step 2    Tekbox Modulated Amplifier    SM FWD PWR Measurement

RMS [dBm]    Peak [dBm]  
-3.01    2.09

**Immunity Measurement ISO 11452-4 SM**

Parameter	Value
Calibration	Level II_SM_AM.icl
Freq Start Sweep[Hz]	1000000
Freq Stop Sweep[Hz]	400000000
Freq Step Sweep[%]	1
Dwell Time Sweep[s]	1
Freq Single[Hz]	1000000
Mode	sweep

TG ON during pause

Messages

TG:

Set up the equipment as shown below. Load the calibration file and press the **play** button. EMCview PRO adjusts the tracking generator level for each frequency point during the test to achieve the RF forward power level specified in the calibration file.

Substitution method, immunity test

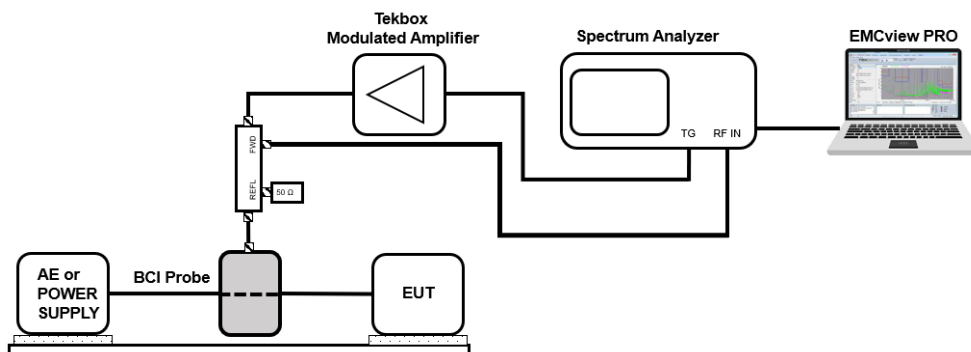

### 32.5 ISO 11452-4, BCI, Closed Loop Method

The Closed Loop Method controls the injected current by measuring the actual injected current using a current probe. Click at the ISO 11452-4 BCI tab and set up the equipment as depicted below:

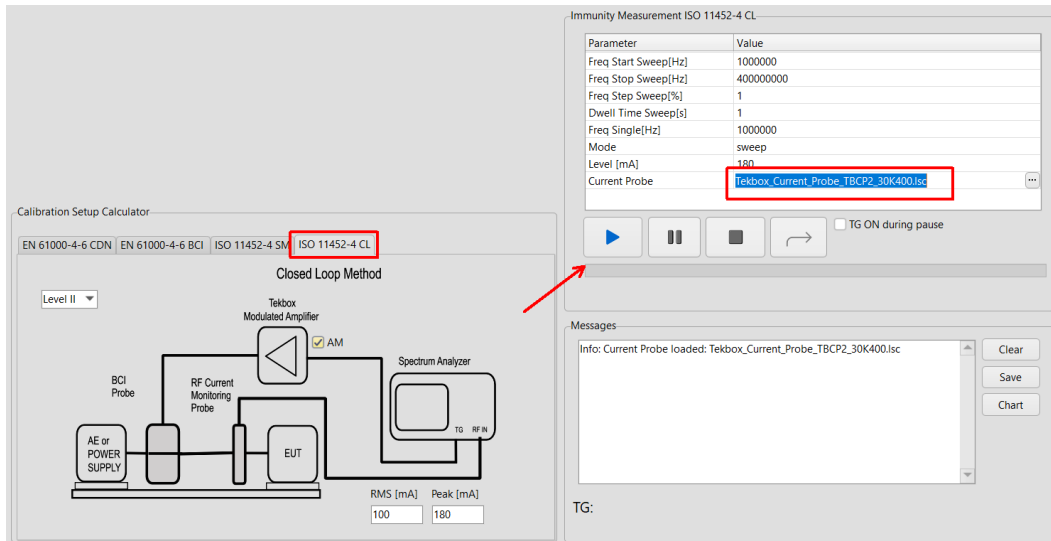

Select the RF current monitoring probe model and the other test parameters and press the Play button. The injected current level will be displayed in a pop-up graph window. In case of AM, the detector of the analyzer will be set to peak, as many analyzers do not have an RMS detector. The corresponding peak current for AM modulation will be displayed.

The injected current may not be achievable for any frequency, especially if ungrounded EUTs are used. At parallel resonances of the cable, the impedance will become very high and maintaining the set current level might exceed the capabilities of the RF power amplifier. This is a common issue associated with the closed loop method. It is documented in the graph, which displays the actual injected current vs frequency. The graph can be saved as image or as CSV file.

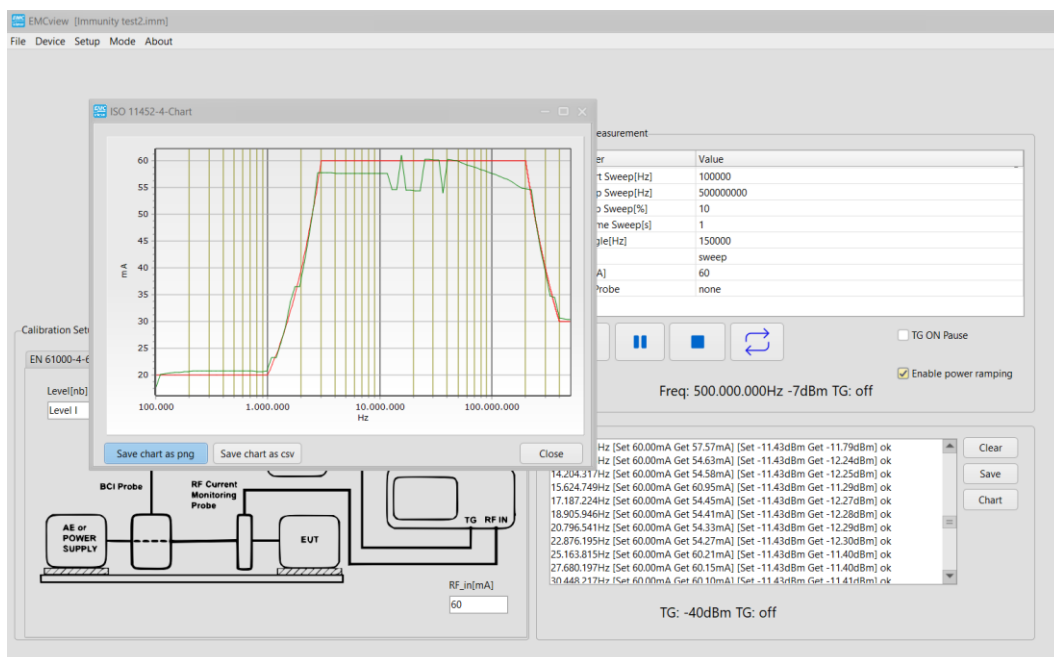

### 33. Create Reports

Click **Setup**, **Edit Report**. Click **Clear** and then enter the report details. Click **Save** and enter a file name. In order to print the report, click **File**, **Utilities**, **Print Report**. If you want to keep the report as a file, print using a pdf writer. To do so, set a pdf writer as default printer in Windows settings.

### 34. Tracking generator control mode for immunity testing

A spectrum analyzer equipped with tracking generator, together with a TEM Cell and a modulated power amplifier from Tekbox can be used very effectively for pre-compliance immunity testing. In order to simplify tracking generator control, click menu **Mode / Generator**.

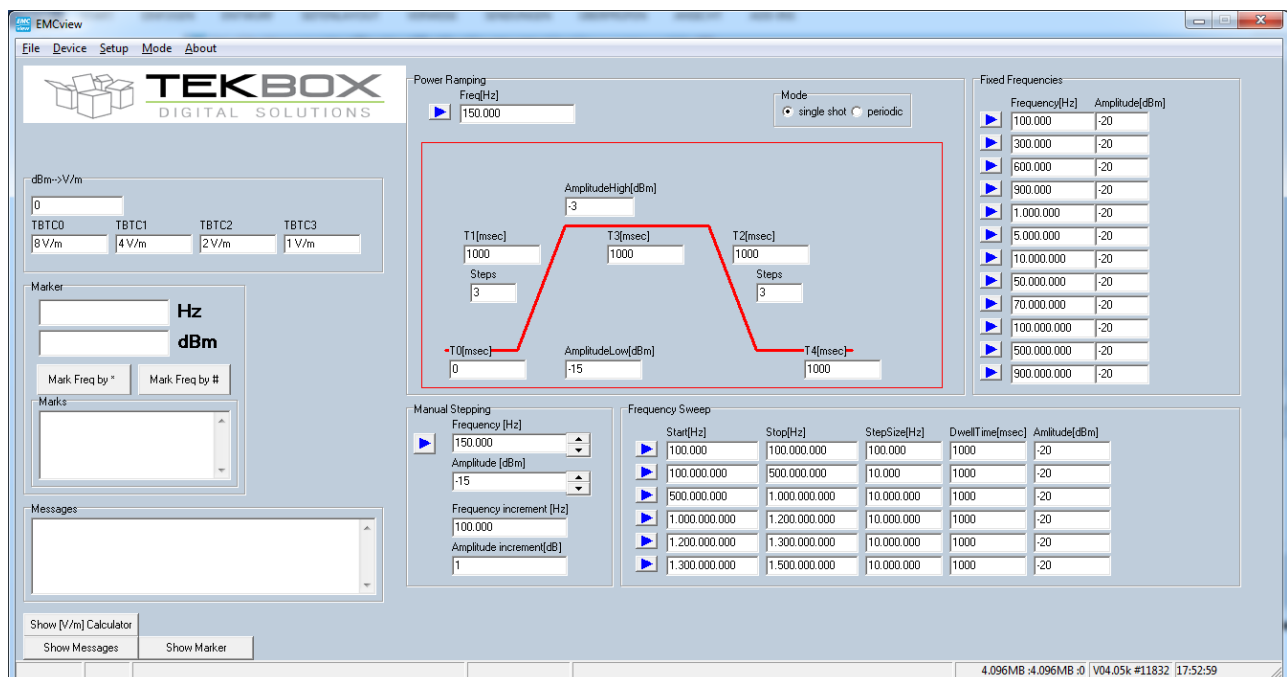

There are three modes to control the tracking generator:

Power Ramping	generates a configurable power ramp profile at a fixed frequency; either as a single pulse or periodic.
Frequency Sweep	carries out a frequency sweep with configurable start and stop frequency, frequency step size, output level and dwell time per frequency point.
Fixed Frequencies	sets the generator to a fixed output frequency and output level
Manual Stepping	manually step frequency and amplitude of the tracking generator

Consider that the amplitude of most tracking generators are limited to the range -20dBm to 0 dBm and to an amplitude step size of 1 dB. For lower output levels, use an external attenuator; for higher output levels use an external amplifier.

An immunity pre-compliance test will typically start with a frequency sweep. The DUT is placed inside a TEM cell and a wideband amplifier will boost the TG signal to the necessary level to create a strong electric field inside the TEM cell. Observe the DUT for any misbehavior during the sweep. In case of observing any DUT malfunction, press the **Mark Frequency** tab to record the frequency.

In order to save time during later re-testing, after modification of the DUT, change to fixed frequency mode, using critical frequencies observed during the sweep.

Check our website for corresponding application notes and for the EMCview FAQ document from time to time.



### 35. RF coverage measurement mode

In RF coverage measurement mode, the field strength of up to 3 transmitters can be monitored in parallel. GPS coordinates are assigned to every measurement sample. EMCview currently supports Opus / Eride chipset based GPS receivers with NMEA output via USB. A suitable GPS receiver is also available from Tekbox.

In order to make RF coverage measurements, connect to the spectrum analyzer and GPS receiver in the **Device** menu. Click **Mode, RF Coverage** to enter RF coverage measurement mode.

#### 35.1 Configuration

Enter the frequencies that you want to observe along with the spectrum analyzer settings:

Parameter	Value
Freq A[Hz]	173575000
Freq B[Hz]	88500000
Freq C[Hz]	146725000
High[dBm]	-10
Low[dBm]	-110
Cable Cor	none
Amp Cor	none
Ant Cor	none
Detector	VAV
Sweep [ms]	auto
RBW [Hz]	10000
Span [Hz]	25000
PreAmp	off
Attenuator [dB]	0

If Freq(B) and or Freq(C) are not required for the measurement, simply delete the contents of the corresponding box.

High[dBm], Low[dBm] values specify the y-axis display range of the graph. The values on the X-axis correspond to the index of the consecutive measurement samples.

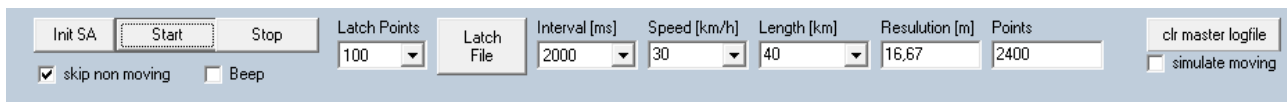

- Init SA: transfers the measurement settings to the spectrum analyzer and initialize the SW for a new measurement
- Start: start measurement or continue interrupted measurement; requires a GPS fix and established connection to the spectrum analyzer.
- Stop: stop measurement
- Latch Points: select the number of measurement points, after which a KML file will be created automatically. If the total number of measurement points exceeds the settings in **Latch Points**, additional KML files will be created.
- Latch File: creates a KML file upon pressing the button
- Interval [ms]: time in between two consecutive measurements (measurement interval). Minimum time largely depends on number of observed frequencies, sweep time and measurement response time of the analyzer. With the analyzer settings in the example above, 3 frequencies can be monitored every 2 seconds. If the set interval time is too low, a timing error will be occur and increment the T3-Err counter at the bottom of the graph.
- Speed [km/h]: enter the estimated average speed of your measurement drive here to calculate the resolution of your measurement
- Length [km]: enter the estimated length of your measurement drive here to calculate the resulting number of measurement points
- Resolution[m]: average distance between two measurement points based on the entered value of Speed and the settings for the measurement interval.
- Points: resulting number of measurement points based on the estimation of the length of the measurement drive and the settings for the measurement interval.
- Clr master logfile: the data of every measurement point is logged into a text file with file name **coverage.txt**. Any additional measurement will be appended to existing data in the

# Tekbox EMCview Manual



log file. Press this button to delete the contents of the log file. The log file is located in the sub directory **out**.

Skip non moving:  
Simulate moving:

Don't log any measurement points if the speed reported by the GPS receiver is zero only to validate the measurement setup; don't click for an actual measurement. The SW generates a random offset to the coordinates measured by the GPS receiver to simulate a test drive.

## 35.2 Status and measurement results



The main graph displays the measured field strength of the observed transmitters on the y- Axis and the index number of the corresponding measurement on the X-axis. The GPS data window displays the coordinates of consecutive measurement points.

Index: index counter; number of current measurement sample  
 Status: displays GPS fix  
 Date: current date  
 Lat dec: current latitude in decimal format  
 NS: latitude north/south  
 Long dec: current longitude in decimal format  
 EW: latitude east/west  
 Speed: current speed  
 UTC: current time  
 T3-Err: error counter, counts timer errors caused by insufficient length of measurement interval  
 Freq A: observed frequency A  
 Level A: field strength/ amplitude of transmitter A  
 Freq B: observed frequency B  
 Level B: field strength/ amplitude of transmitter B  
 Freq C: observed frequency C  
 Level C: field strength/ amplitude of transmitter C  
 Recent kml file: shows the path and file name of the latest generated kml file: default directory is **out**. The kml file is created automatically and consists of the string **out\_date\_time.kml**.

## 35.3 Log file

The index file is a text file containing an index for each sample, date, time, longitude, latitude, speed, observed frequencies and corresponding field strength.

Example:

```
Index;Fix;Date;UTC;Lat;NS;Long;EW;Speed[km/h];FreqA[Hz];LevA[dBm];FreqB[Hz];LevB[dBm];FreqC[Hz];LevC[dBm]
0;fix;031217;133951.086;47.2786633333;N;11.5031383333;E;19,8164;173575000;-61.62;88500000;-55.71;146725000;-102.30
1;fix;031217;133953.086;47.2785533333;N;11.5031883333;E;23,46484;173575000;-66.53;88500000;-67.06;146725000;-104.70
2;fix;031217;133955.086;47.2784366667;N;11.5032450000;E;24,20564;173575000;-77.26;88500000;-58.54;146725000;-104.80
3;fix;031217;133957.086;47.2783266667;N;11.5033033333;E;22,35364;173575000;-86.61;88500000;-56.00;146725000;-104.00
....
```

## 35.4 KML file

The KML file can be used to project the measurement drive into Google Earth Professional. The altitude-profile graph feature of Google Earth Professional is utilized to display a field strength profile. The [m] unit displayed by Google Earth is equivalent to the measured amplitude in [-dBm]. Consequently, peaks in the graph represent lower field strength values, means the graph is mirrored on the x-axis. In Google Earth menu **View**, **reset tilt**. If you don't see the track, in **Layers**, activate **More**. In order to see the field strength profile, click the **Edit** menu and then show **elevation profile**.

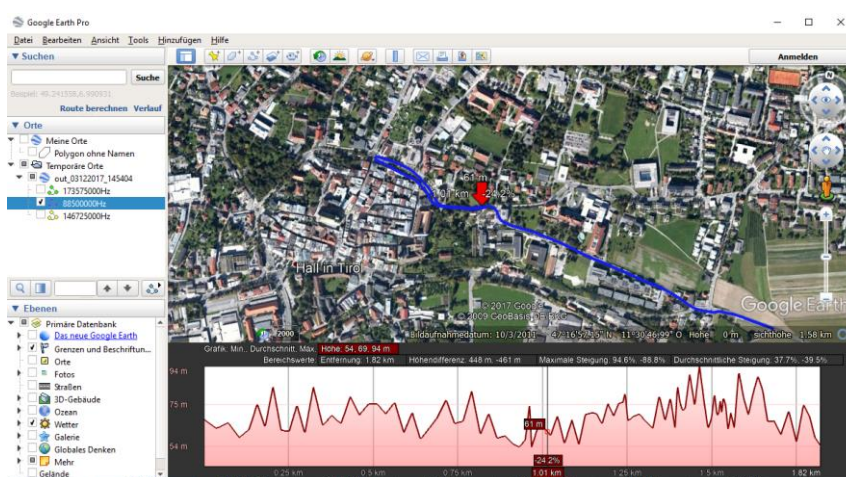

## 36. Further information

**Read the EMCview FAQ document for more detailed information. Also check our website from time to time for software updates, new project packages and useful application notes.**

## 37. History

Version	Date	Author	Changes
V 1.0	20.04.2017	Mayerhofer	Creation of the document
V 1.1	26.04.2017	Mayerhofer	Chapter 2 (warnings) added
V 1.2	21.06.2017	Mayerhofer	Siglent support added
V 1.3	16.12.2017	Mayerhofer	Updates - SW REV 3.0
V 1.4	6.6.2018	Mayerhofer	Updates - SW REV 4.0
V 1.5	9.10.2018	Mayerhofer	Updates - SW REV 4.05
V 1.6	9.10.2018	Mayerhofer	Chapter 1 and 2 updated
V 1.7	9.4.2020	Mayerhofer	Chapter 1, 2, 16, 18 and 22 updated
V 1.8	6.5.2020	Mayerhofer	Chapter – SW REV 6.01
V 1.9	6.5.2020	Mayerhofer	Chapter 22 inserted – SW REV 6.07
V 2.0	25.9.2020	Mayerhofer	Chapter 9, 10, 12, 13 inserted – SW REV 7.0
V 2.1	1.4.2021	Mayerhofer	Information on changed peak re-measurement UI with EMCview V8.0
V 2.2	4.11.2021	Mayerhofer	Information on restoring measurement set-ups with EMCview V8.12 and higher
V 2.3	6.6.2022	Mayerhofer	Update referring to changes with EMCview V8.30 and higher
V 3.0	10.8.2023	Mayerhofer	Update for the release of EMCview V8.64
V 3.1	4.12.2023	Mayerhofer	Update for the release of EMCview V9.06
V 3.0	23.12.2023	Mayerhofer	Update for the release of EMCview V9.17